

Technical data sheet

Conceptpower DPA 120 UL

208V 20 – 120kW

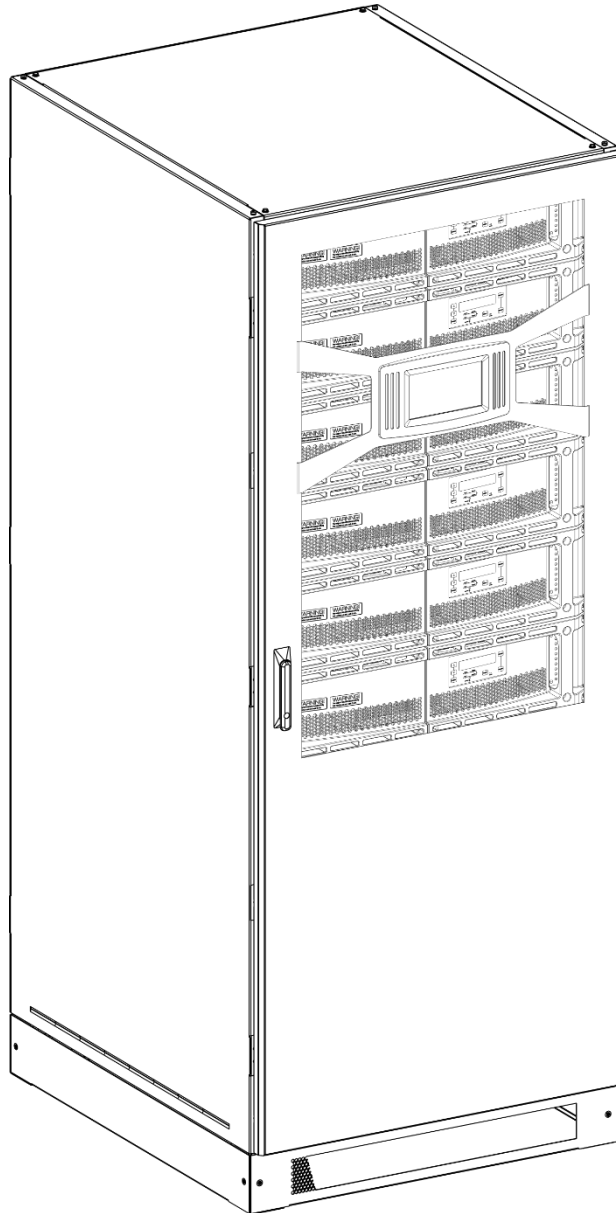

Document information

File name : TDS_ABB_CP_DPA_120_UL_REV-B.docx
UPS model : Conceptpower DPA 120 UL
Date of issue : 19.08.2016
Article number : N/A
Document number : 4NWD003251
Revision : B

Contents

1	System description	4
1.1	True modularity up to 600 kW	4
1.2	True parallel architecture.....	4
1.3	Key Features of Conceptpower DPA 120 UL UPS.....	4
2	General characteristics	5
3	Input characteristics	7
4	Output characteristics	8
4.1	Online double conversion efficiency with linear, resistive load	9
5	Battery characteristics.....	10
6	User interface - Communication.....	10
6.1	System graphical display	10
6.2	DPA module display	11
6.3	Mimic Diagram	11
7	Customer interfaces.....	12
7.1	Customer inputs dry ports: Terminal blocks X3 / 3-14.....	12
7.2	Outputs dry ports: Terminal blocks X2 + X3 / 1-2.....	12
7.3	Interlock castell function: Terminal block X1	12
8	Options	14
8.1	On request.....	14
9	UPS location.....	15
10	Heat dissipation per module with nonlinear load	16
11	Single input feed and separate batteries configuration	17
11.1	Block diagram	17
11.2	Cable sections & fuse ratings	17
12	Dual input feed and common battery configuration	18
12.1	Block diagram	18
12.2	Cable sections & fuse ratings	18

1 System description

ABB's Conceptpower DPA 120 UL UPS is a high-power, modular and transformer-less UPS system for organizations who need to maximize uptime. The UPS is built using true online double conversion technology and provides low cost of ownership.

1.1 True modularity up to 600 kW

Now you can have a UPS sized to exactly fit your needs: the Conceptpower DPA 120 UL UPS is the only modular UPS on the market that can easily be scaled up to 600kW of clean, reliable power. This scalability means that there is no need to over-specify the original configuration as power modules can simply be added, as needed, in the future

1.2 True parallel architecture

Reliability and availability are ensured by the Conceptpower DPA 120 UL UPS's proven Decentralized Parallel Architecture (DPA™). Each module contains all the hardware and software required for full system operation, they share no common components. Each UPS module has its own independent static bypass, rectifier, inverter, logic control, control panel, battery charger and batteries. With all the critical components duplicated and distributed between individual units, potential single points of failure are eliminated.

1.3 Key Features of Conceptpower DPA 120 UL UPS

- 20 kW rated power module
- 120 kW rated power in single frame
- Extended power range: from 20 kW to 600 kW
- Unity output power factor (kVA = kW)
- Double conversion efficiency up to 94.0 %
- Efficiency in eco-mode ≥ 99 %
- Online Swap Modularity (OSM)
- Online serviceability
- Built-in back-feed protection (standard)
- Graphical display on system level
- DPA displays in each module

This technical datasheet (TDS) provides all technical specification required by IEC 62040-3 and ANSI/UL 1778 5th Ed., providing mechanical, electrical and environmental characteristics. It can be used for tendering and end-user requirements. CONCEPTPOWER DPA 120 UL UPS is designed to respond to the actual UPS standards.

2 General characteristics

Frame

Conceptpower DPA 120 UL

Conceptpower DPA 120 UL - Frame

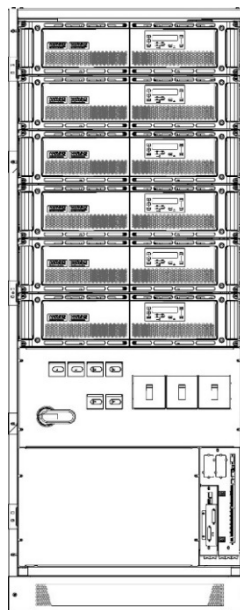

Power, rated:

- Apparent	kVA	120
- Active	kW	120

Power, range	kW	20 - 600
--------------	----	----------

UPS type: On-line, transformer-less, modular, decentralized parallel architecture

Parallel capability: Up to 5 frames

Battery: Not included

Performance classification: VFI-SS-111

Mechanical

Dimensions (width x height x depth)	mm	791 x 1975 x 923
	in	31.16 x 35.17 x 77.76

Mass, approx. (120kW system, with 6 modules)	kg	665
	lbs.	1466

Acoustic noise (acc. to IEC 62040-3):

- In normal mode (at $\leq 25^{\circ}\text{C}$) at 100% / 50% Load	dBA	71 / 68
- In battery mode (at $\leq 25^{\circ}\text{C}$) at 100% / 50% Load	dBA	71.5 / 69

Safety

Access: operator/restricted

Degree of protection against hazards and water ingress: NEMA 1 / IP 20

Electromagnetic compatibility

Compliant:

- Emission UPS Cat / Immunity UPS Cat C3 / C3

Environmental

Storage temperature range	°C	-25 - +70
Operative temperature range	°C	0 - +40
Relative humidity range (non-condensing)	%	≤ 95
Max. altitude without de-rating	m	1000

Additional and usual information

Connection: 5 wires, 3 phase + N + PE

Cable entry: Bottom

Accessibility: Frontal only

Color: Powder coat MIDNIGHT BLACK Wrinkle

Color code: Rohm & Haas #12-7001

Module

Conceptpower DPA 120 UL

Conceptpower DPA 120 UL - UPS

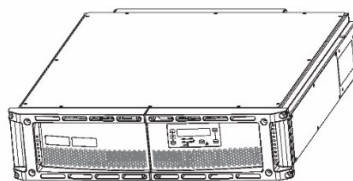

Power, rated:

- Apparent	kVA	20
- Active	kW	20

UPS type: On-line, transformer-less, modular, decentralized parallel architecture

Parallel capability: Up to 5 frames

Battery: Not included

Performance classification: VFI-SS-111

Mechanical

Dimensions (width × height × depth)	mm	710x178x750
	in	27.95 x 7.00 x 29.53
Mass, approx.	kg	60
	lbs.	132

Additional and usual information

Back feed protection: Included

Color: (RAL 9005)

3 Input characteristics

Type		Frame	Module
Power, rated	kW	120	20
Voltage (steady-state, r.m.s), rated:	VAC	3 x 208 / 120V + N	
- Tolerance, referred to 208/120V (booster off)	%	-15% / +10%	
- Operative ranges, referred to 208/120V (booster on)	%	-15 / + 10 at <100% load -20 / + 10 at <80% load, -30 / + 10 at <60% load	
Frequency, rated:	Hz	50/60	
- Tolerance, referred to 50Hz	%	-30 / +40	
Current (r.m.s), rated (with battery charged and input 208/120V):	A	360	60
- Maximum (with battery charging and input 208/120V)	A	363	61
Total harmonic distortion (THDi) ¹⁾	%	4	
In-rush current	%	< 100% of rated current	
Power factor		0.99 @ 100% load	
Rated short-time withstand current (I _{cw})	kA	5	NA
AC power distribution system: TN-S, TN-C, TN-C-S, TT			
Note: in static bypass mode or eco-mode TN-C and TN-C-S can cause PE current to rise above 5% of phase currents			
Phases required		3	
Neutral required		Yes	

¹⁾ Measured with MAIN THDu < 3% @ full load and rated input output voltage; ±0.3 tolerance may apply

Additional and usual information

Connection: 5 wires, 3 phase + N + PE

Cable entry: Bottom

Accessibility: Front access only

Walk In/Soft start: Yes

Back feed protection: Yes

4 Output characteristics

Type		Frame	Module
Power, rated	<i>kW</i>	120	20
AC power distribution system: TN-S, TN-C, TN-C-S, TT			
Available phases		3	
Neutral available		yes	
Voltage (steady state, r.m.s.), rated	<i>VAC</i>	3 x 208 / 120V + N	
Variation in normal mode	%	± 2.5	
Total harmonic distortion (THDu), 100% load, normal mode:			
- Linear	%	< 2.0	
- Non-linear	%	< 4.0	
(according to IEC 62040-3)			
Total harmonic distortion, 100 % load, battery mode:			
- Linear	%	< 2.0	
- Non-linear	%	< 4.0	
(according to IEC 62040-3)			
Voltage unbalance and phase displacement, 100 % load unbalance	°	0	
Voltage transient and recovery time, 100% step load:			
- Linear	%	± 4	
- Non-linear	%	± 4	
(according to IEC 62040-3)			
Transfer normal mode --> battery mode	%	0	
Frequency (steady-state), rated:	<i>Hz</i>	50/60	
- Variation in normal mode (frq. Synchronized with mains)	%	± 2 / ± 4	
- Variation in battery mode (free-running)	%	± 0.1	
Max synch phase error (referred to a 360° cycle)	°	<2	
Max slew-rate	<i>Hz/s</i>	1	
Nominal current (In), r.m.s. rated	<i>A</i>	333	56
Overload on inverter	<i>min</i>	0.5 @ 150% load, 5 @ 125% load, 20 @ 110% load	
Fault clearing capability normal mode and battery mode for 100ms	<i>A</i>	1008 (3xIn)	168 (3xIn)
Load power factor, rated		1	
Displacement (permissible lead-lag range)	%, s	(all range) 0	

Online double conversion efficiency in normal mode with linear load:

- 100% load	%	93.5 ²⁾
- 75% load	%	93.9 ²⁾
- 50% load	%	94.0 ²⁾
- 25% load	%	93.0 ²⁾

Eco-mode efficiency with linear load:

- 100% load	%	98.7 ²⁾
- 75% load	%	98.8 ²⁾
- 50% load	%	99.0 ²⁾
- 25% load	%	99.1 ²⁾

Crest – Factor 3:1
(Load supported)

4.1 Online double conversion efficiency with linear, resistive load

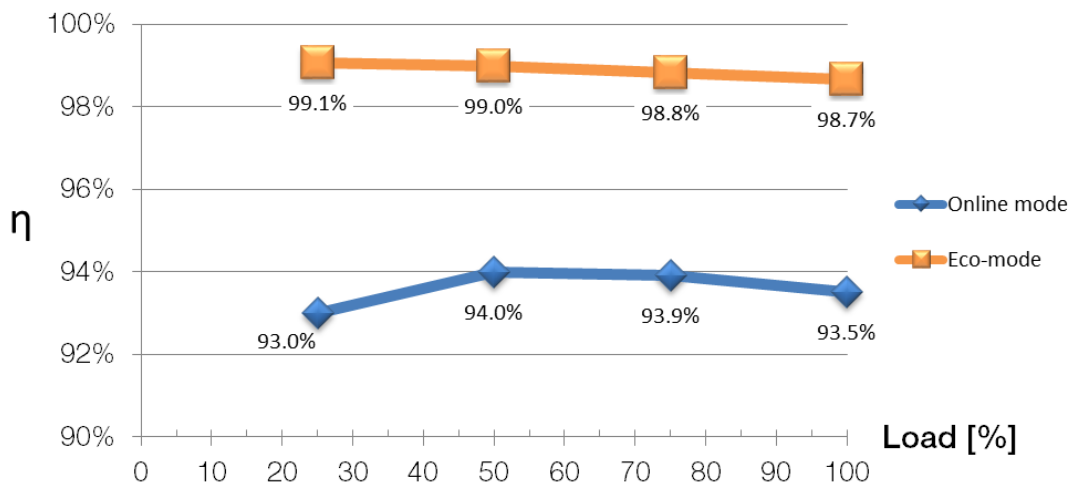

²⁾ Tolerance of +/- 0,2% may apply

Static bypass

Type: Automatic, static switch in each module

Transfer times:

- inverter → bypass	ms	<1
- bypass → inverter		<5
- in eco-mode		<6

Rated current	A	333	56
Fault clearing capability (bypass mode) for 20 ms	A	10xIn	10xIn
Overload current on bypass mode (< 25°C)	min	continuously @ 110% load	

Maintenance bypass: optional on the frame

Bypass protection fuse or circuit breaker rating	A, gL fuse	3x70
---	------------	------

5 Battery characteristics

Technology		VRLA, vented lead-acid, NiCd
Number of 12 V blocks		25 - 35
Number of 1.2 V NiCd cells		250 - 350
Battery charger		Decentralized, each module has its own charger
Max. current charger capability	A	24
Max. power charger capability	kW	12
Floating voltage (VRLA / NiCd)	VDC	2.25 / 1.40
End of discharge voltage (VRLA / NiCd)		1.65 / 1.05
R.m.s. ripple current (percentage of the battery capacity)	%	2
Temperature compensation		Optional
Battery test		Automatic and periodic battery test (selectable)

6 User interface - Communication

System Display	7" touchscreen display (one per frame)
DPA display (or module display)	2 x 20 character LCD display (one per module)
MIMIC diagram	LED-indicator, 5x green/red LEDS (one per module)
RS232 on Sub-D9 port RS232 on USB port	For monitoring and integration in network management
Customer Interfaces Inputs DRY PORT	1 Remote Shut down [EMERGENCY OFF (Normally closed)] 1 GEN-ON (Normally open) 1 Programmable Customer's Inputs (Normally open) 1 Temp. Sensor for Battery Control
Customer Interfaces Outputs DRY PORT	6 voltage free contacts For remote signaling and automatic computer shutdown
RS485 on RJ45 port [OPTIONAL]	Remote monitoring system with remote panel (graphical display)
RS485 on RJ45 port [OPTIONAL]	For multi-drop purpose
Slot for SNMP [OPTIONAL]	SNMP card For monitoring and integration in network management

6.1 System graphical display

The user-friendly touchscreen graphical display on the system level offers the opportunity to directly monitor the system status as well as the status of each individual module. The graphical display

additionally provides all measurements (at module and system level) and the user can transfer from the inverter to bypass and vice-versa. All other commands must be performed on the DPA display. With both displays in place (module and system level), the UPS offers full user friendliness without making compromises on robustness.

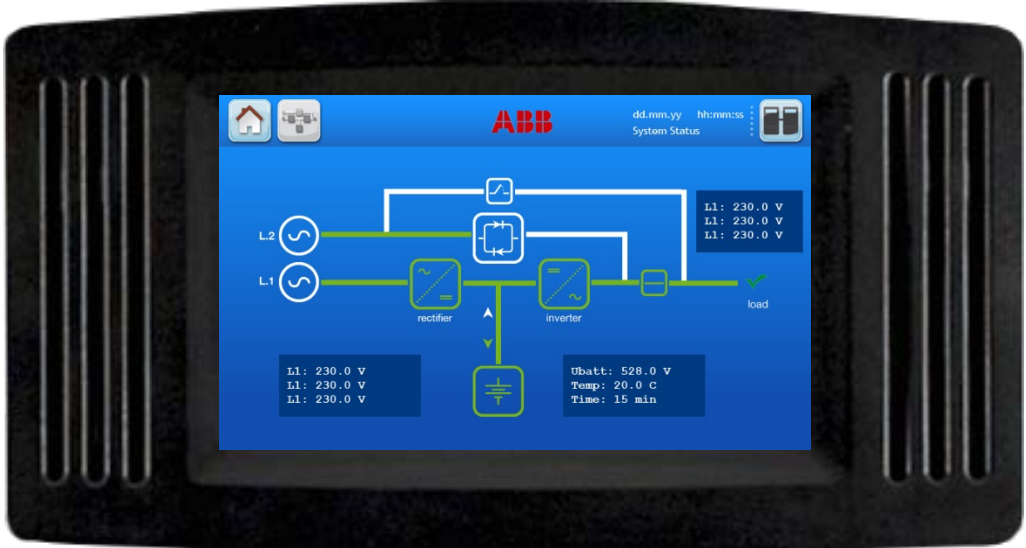

6.2 DPA module display

The 2 x 20 character LCD simplifies the communication with the UPS. The menu driven LCD enables the access to the EVENT REGISTER, or to monitor the input and output U, I, f, P, Autonomy Time and other Measurement's, to perform commands like start-up and shut-down of INVERTER or load transfer from INVERTER to BYPASS and vice-versa and finally it serves for the DIAGNOSIS (SERVICE MODE) for adjustments and testing (for more details see the USER MANUAL).

6.3 Mimic Diagram

The mimic diagram serves to give the general status of the UPS. The LED-indicators show the power flow status and in the event of mains failure or load transfer from inverter to bypass and vice-versa the corresponding LED-indicators will change colour from green (normal) to red (warning). The LED's LINE 1 (rectifier) and LINE 2 (bypass) indicate the availability of the mains power supply. The LED's INVERTER and BYPASS if green indicate which of the two are supplying power to the critical load. When the LED-indicator BATTERY is lit it means that the battery due to mains failure is supplying the load. The LED-indicator ALARM is a visual indication of any internal or external alarm condition. At the same time the audible alarm will be activated.

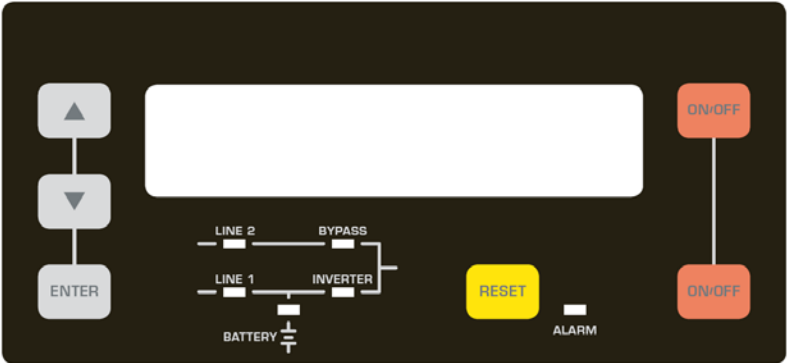

7 Customer interfaces

7.1 Customer inputs dry ports: Terminal blocks X3 / 3-14

Connection of Remote Shut down facilities, Generator Operation, Customers specials (*refer to the user manual*).

7.2 Outputs dry ports: Terminal blocks X2 + X3 / 1-2

Provision of signals for the automatic and orderly shutdown of servers, AS400 or Automation building systems

7.3 Interlock castell function: Terminal block X1













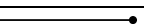



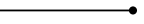

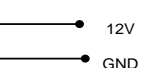

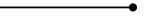
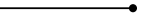

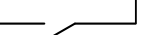
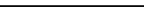

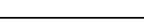
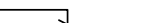

This function allows a secure transfer from inverter (normal operation) to external maintenance bypass and vice-versa. During normal operation the external bypass is locked in position OFF. Only when the UPS is/are transferred to static bypass mode, the lock on the external bypass is released and it possible to switch to position ON. The transfer from maintenance bypass back to normal operation happens exactly the other way around. The release signal is a closed contact when the maintenance bypass is free and an open contact when locked.

All Terminals X1-X3 can hold Cable from AWG 24 to AWG 15.

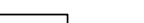
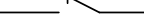
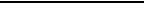
X1 is a dry contact for monitoring an external output switch and can be used as interlock function.

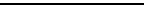
All X2 are potential free contacts and are rated: 30Vdc/2A; 60Vdc/0.7A

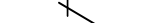
All X3 (except X3 5/6 which is a 12VDC source) are inputs, cable max. R 50Ω at 20mA

Block	Terminal	Contact	Signal	On Display	Function
X3	X3 / 14	GND 	GND	-	Battery Temperature
	X3 / 13	IN 	+3.3VDC	-	(only the optional battery sensor from ABB is compatible)
	X3 / 12	GND 	GND	GENERATOR_ OPER_ON	Generator Operation (N.O.) Min. contact load 12V / 1mA
	X3 / 11	IN 	+12Vdc		
	X3 / 10	GND 	GND	PARRALEL_SW_OPEN PARRALEL_SW_CLOSE	External Output Breaker (N.O.) Min. contact load 12V / 20mA.
	X3 / 9	IN 	+12Vdc		
	X3 / 8	GND 	GND	EXT_MAN_BYP	External Manual Bypass (Ext. IA1) (N.O.) Min. contact load 20mA
	X3 / 7	IN 	+12Vdc		
	X3 / 6		+12Vdc	-	+ 12 VDC source (UPS protected) (Max. 200mA)
	X3 / 5		GND	-	
	X3 / 4	GND 	GND	REMOTE_ SHUTDOWN-	RSD (Remote Shut down) Default setting: disabled. Possibility to enable and set NO or NC via NewSet.
	X3 / 3	IN 	+12Vdc		
	X3 / 2	C 	-	REMOTE_ SHUTDOWN-	RSD (Remote Shut down) for external switch Max. 250Vac/8A ;30Vdc/8A ;110Vdc/0.3A ;220Vdc/0.12A
	X3 / 1	NO 	-		
X2	X2 / 18	C 	-	-	Common
	X2 / 17	NC 	-	-	Relay AUX (function on request, to be defined)
	X2 / 16	NO 	-	-	
	X2 / 15	C 	-	COMMON_ALARM	Common
	X2 / 14	NC 	ALARM	-	No Alarm Condition
	X2 / 13	NO 	-	-	Common Alarm (System)
	X2 / 12	C 	-	LOAD_ON_MAINS	Common
	X2 / 11	NC 	Message	-	No Load on Bypass
	X2 / 10	NO 	-	-	Load On Bypass (Mains)
	X2 / 9	C 	-	BATT_LOW	Common
	X2 / 8	NC 	ALARM	-	Battery Ok
	X2 / 7	NO 	-	-	Battery Low
	X2 / 6	C 	-	LOAD_ON_INV	Common
	X2 / 5	NC 	Message	-	No Load on Inverter
	X2 / 4	NO 	-	-	Load on Inverter
	X2 / 3	C 	-	MAINS_OK	Common
	X2 / 2	NC 	ALARM	-	Mains Failure
	X2 / 1	NO 	-	-	Mains Present
X1	X1 / 2		-	EXT_MAN_BYP	Interlock Function Max. 30Vdc/2A; 60Vdc/0.7A (Ext Manual Bypass) / 2AT
	X1 / 1		-		

Phoenix Spring Terminals (X1...X2) Connection

8 Options

ARTICLE	DESCRIPTION	DETAIL
PRODUCT OPTIONS OR FEATURES – MODULE		
4NWP101921R0001	Cold start DPA Module UL	Available for 20kW and 40kW modules
4NWP102254R0001	Sync Feature CP DPA 120-240 mod. - SP102	Available for 20kW and 40kW modules
PRODUCT OPTIONS OR FEATURES – ELECTRONICS & SOFTWARE		
00-2907	Parallel adapter	For 1 UPS frame.
04-3630	Parallel Cable Kit 5m	Includes multidrop cable.
04-3631	Parallel Cable Kit 10m	Includes multidrop cable.
04-3632	Parallel Cable Kit 15m	Includes multidrop cable.
04-3633	Parallel Cable Kit 20m	Includes multidrop cable.
04-3634	Parallel Cable Kit 25m	Includes multidrop cable.
4NWP101937R0001	Maintenance Bypass Switch	3-phase switch, rated 400A 600VAC. Factory mounted only.
4NWP101929R0001	Battery Breaker for CP DPA 120UL	Factory mounted only.
4NWP101946R0001	Transient Voltage Surge Suppressor 120V	Factory mounted only.
PRODUCT OPTIONS OR FEATURES – EXTERNAL BATTERIES		
00-3563	Temperature probe for batteries	Cable length 1.3m.
PACKAGING		
4NWP100585R0001	Carton box for 1 module of 710x178x750mm	Only needed if modules are shipped outside the racks. Stackable up to 2.
4NWP101978R0001	Sea freight case CP DPA 120-240 UL	
DOCUMENTATION		
00-2976	Certificate of origin	Legalized invoice is also available.
04-0160	Duplicate of the commissioning report	
04-0161	Duplicate of archived commissioning rep.	
OTHER		
4NWP102309R0001	1y. extra warranty for 1 20-40kW module	Available for 20kW and 40kW modules

8.1 On request

- Connectivity options
- Bypass transformers
- Input / Output transformers for galvanic isolation or special voltages

9 UPS location

The minimum needed clearances to allow proper airflow on the UPS system and to allow proper service and maintenance shall be respected as reported below:

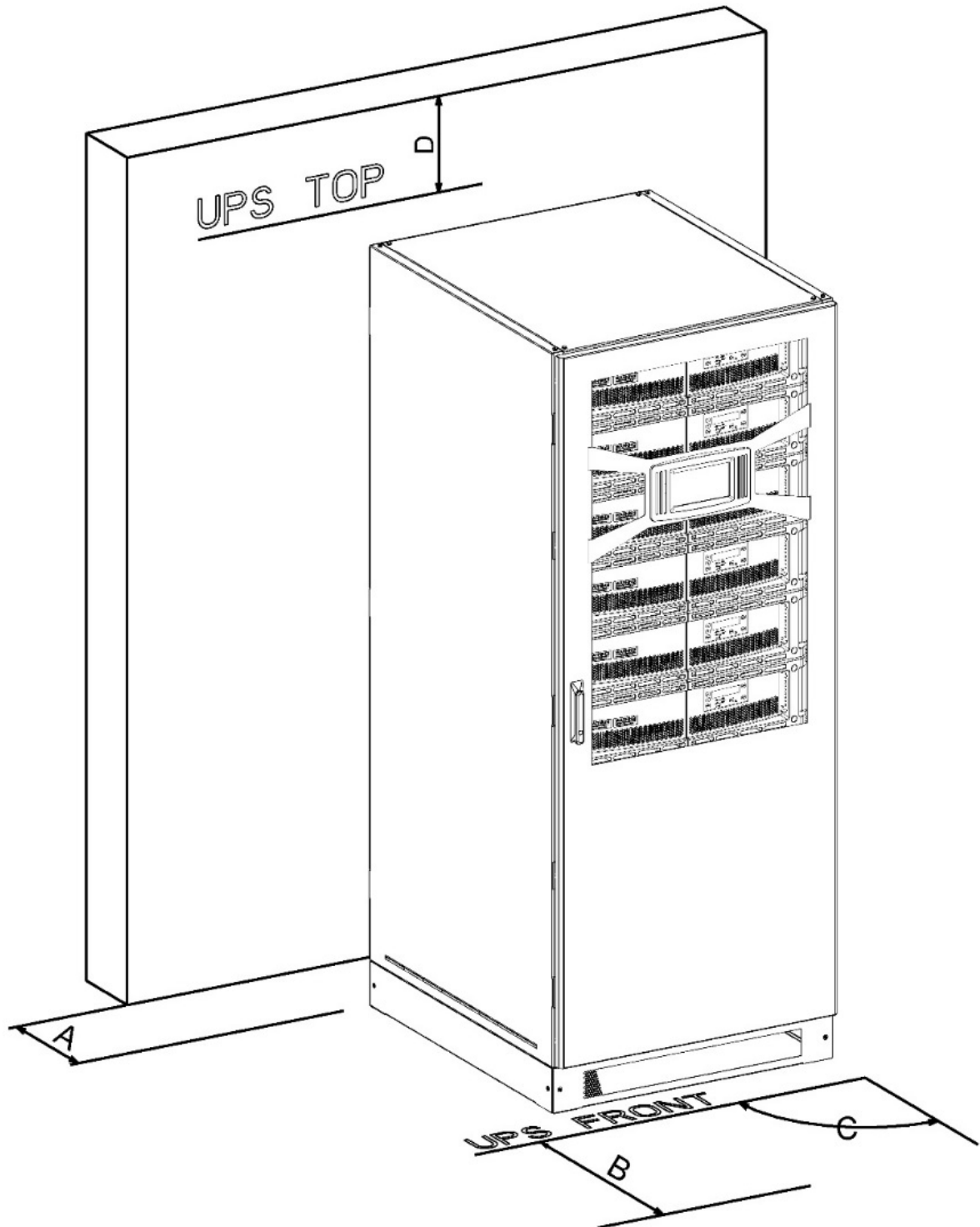

Fig. 8.3-1: UPS and battery location (Clearances)

A	Back clearance for ventilation (forced air outlet)	300 mm
B	Front clearance needed to allow a correct door opening	1000 mm
C	Maximum door opening angle	115°
D	Top Clearance (<i>Top clearance is only needed if there is no side clearance</i>)	400 mm

10 Heat dissipation per module with nonlinear load

Number of modules		1	2	3	4	5	6
UPS power rating	<i>kW</i>	20	40	60	80	100	120
Heat dissipation with 100% linear load	<i>W</i>	1390	2780	4170	5561	6950	8340
	<i>BTU</i>	4743	9485	14229	18970	23715	28458
Heat dissipation with 100% non-linear load (according to IEC 62040-3)	<i>W</i>	1600	3200	4800	6400	8000	9600
	<i>BTU</i>	5460	10920	16380	21840	27300	32760
Airflow (25° - 30°C) with 100% non-linear load (according to IEC 62040-3)	<i>m³/h</i>	690	1380	2070	2760	3450	4140
Heat dissipation without load	<i>W</i>	200	400	600	800	1'000	1'200

11 Single input feed and separate batteries configuration

Cable sections and fuse ratings recommended. Alternatively, local standards to be respected

11.1 Block diagram

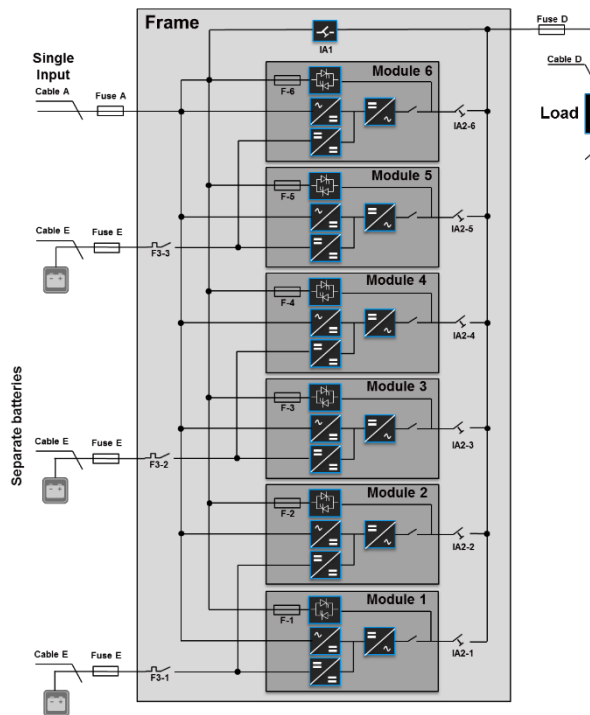

11.2 Cable sections & fuse ratings

Recommended AC wiring (copper wires) according to current normative, recommended fuse ratings for slow line fuses (gL) or circuit breakers (CB), connection terminal size and max. tightening torque.

Rated power (kW)	Single input Max. rectifier input current with charging batt. 363A at 120V		Output Rated output current in normal conditions 333A at 120V	
	Fuse A Type: gL or CB (quantity x A)	Cable A (quantity x Kcmils)	Fuse D Type: gL or CB (only needed in parallel system) (quantity x Kcmils)	Cable D (quantity x Kcmils)
120	3 x 450A (3 pole, bolded N)	3x(2x250) PH + 4x250 N ¹⁾ + 2x250 PE	3 x 450A (3 pole, bolded N)	3x(2x250) PH + 4x250 N + 2x250 PE
	All connection points are bus-bar, M12. Max. tightening torque 84.8 Nm			

Recommended DC wiring (copper wires) according to current normative, recommended fuse ratings for fast acting fuses (gR) or circuit breakers (CB), connection terminal size and max. tightening torque.

Separate batteries		
Rated power (kW)	Fuse E Type: gR or CB (quantity x A)	Cable E (quantity x AWG)
20 (one module)	3 x 125A (3 pole)	2x(1x1) + 1x1 PE
	All connection points are terminal blocks, Max. tightening torque 5 Nm	

¹⁾ Four neutral cables are required for full non-linear load operation only

12 Dual input feed and common battery configuration

Cable sections and fuse ratings recommended. Alternatively, local standards to be respected

12.1 Block diagram

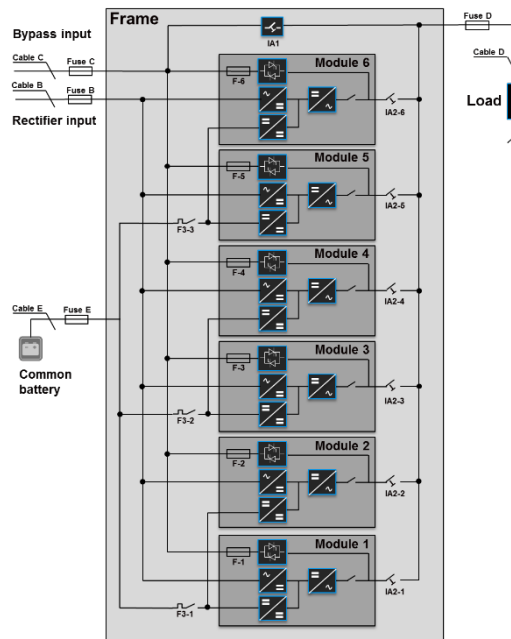

12.2 Cable sections & fuse ratings

Recommended AC wiring (copper wires) according to current normative, recommended fuse ratings for slow line fuses (gL) or circuit breakers (CB), connection terminal size and max. tightening torque.

Rated power (kW)	Rectifier input Max. rectifier input current with battery charging 363A at 120V		Bypass input Max. bypass input current 333A at 120V		Output Rated output current in normal conditions 333A at 120V	
	Fuse B Type: gL or CB (quantity x A)	Cable B (quantity x Kcmils)	Fuse C Type: gL or CB (quantity x A)	Cable C (quantity x Kcmils)	Fuse D Type: gL or CB (only needed in parallel system) (quantity x A)	Cable D (quantity x Kcmils)
120	3 x 450A (3 pole, bolded N)	3x(2x250) PH + 4x250 N ¹⁾	3 x 450A (3 pole, bolded N)	3x(2x250) PH + 4x250 N + 2x250 PE	3 x 450A (3 pole, bolded N)	3x(2x250) PH + 4x250 N + 2x250 PE
All connection points are bus-bar, M12. Max. tightening torque 84.8 Nm						

Recommended DC wiring (copper wires) according to current normative, recommended fuse ratings for fast acting fuses (gR) or circuit breakers (CB), connection terminal size and max. tightening torque.

Common battery		
Rated power (kW)	Fuse E Type: gR or CB (quantity x A)	Cable E (quantity x Kcmils)
120	2x630A (2 pole)	2x(3x250) + 2x250 PE
All connection points are bus-bar, M12. Max. tightening torque 84.8 Nm		

¹⁾ Four neutral cables are required for full non-linear load operation only

Contact us

www.abb.com/ups
ric.sales@us.abb.com

© Copyright ABB. All rights reserved.
Specification subjects to change without notice.

