

—
USER MANUAL

PowerValue 11 RT G2

1-3 kVA









About this manual

Document information

File name	:	4NWD005357_ABB_OPM_PVA11 1-3kVA-RT_G2_EN_REV-A
UPS model	:	PowerValue 11 RT G2 1-3 kVA
Date of issue	:	27.02.2020
Issued by	:	Product Marketing
Checked by	:	R&D
Article number	:	N/A
Document number	:	4NWD005357
Revision	:	A

Safety symbols and warnings

The following symbols are used in this manual, the list below explains each symbol.

	This symbol in conjunction with the signal word "DANGER" indicates an imminent electrical hazard. Failure to observe the related safety note may cause injury, death or equipment damage.
	This symbol in conjunction with the signal word "WARNING" indicates a potentially dangerous situation. Failure to observe may cause injury, death or equipment damage.
	This symbol in conjunction with the signal word "NOTE" indicates operator tips or particularly useful or important information for the use of the product. This symbol and wording does not indicate a dangerous situation.
	This symbol indicates that reading the instruction manual/booklet before starting work or before operating equipment or machinery is compulsory.
	Recycle.
	Do not dispose of with ordinary trash.

Contents

1	Important safety instructions	4
1.1	Operator precautions	4
1.2	Environmental considerations	4
1.3	Declaration of safety conformity and CE marking	5
1.4	Inquiries	5
1.5	Operation	5
2	Maintenance	6
2.1	UPS disposal and recycling	7
2.1.1	For professional users in the European Union	7
2.1.2	For disposal in countries outside of the European Union	7
3	Installation	8
3.1	Delivery, transportation, positioning and storage	8
3.1.1	Receipt of the UPS and visual inspection	8
3.1.2	Unpacking list	8
3.1.3	Operation of UPS	8
3.1.4	Storage of UPS	8
3.2	Site planning and positioning	9
3.2.1	Planning before the installation	9
3.2.2	Positioning	9
3.2.3	Rack-mount installation	9
3.2.4	Standalone / tower installation	11
3.2.5	PowerValue 11 RT G2 3kVA S installation	12
3.3	General characteristics	13
3.3.1	UPS front panel	13
3.3.2	UPS rear panel	13
4	Operation	15
4.1	Control panel	15
4.1.1	Selection keys	15
4.1.2	LCD	16
4.2	Operating mode	17
4.3	UPS start-up and shutdown	18
4.3.1	UPS start-up	18
4.3.2	UPS shutdown	18
4.4	LCD wordings index	19
4.5	LCD panel	20
4.6	LCD settings	21
4.7	LCD measurement functions	29
5	Battery replacement	30
6	Communication	31
6.1	RS-232 port	31
6.2	USB port	32
6.3	Emergency power off	32
6.3.1	Dry IN	32
6.3.2	Dry OUT	32
6.4	Network management card (optional)	33
6.4.1	Installing a serial network management card (optional)	33
6.4.2	Monitoring software	33
7	Troubleshooting	34
7.1	Fault identification and rectification	34
7.2	Accessing alarms	34
7.2.1	Faults Reference Code	34
7.2.2	Warning indicator	34

1 Important safety instructions



READ THIS IMPORTANT SAFETY
INSTRUCTION CHAPTER BEFORE
READING THE OPERATING MANUAL

1.1 Operator precautions

Always follow the precautions and instructions described in this manual. Any deviations from the instructions may result in electric shock or cause accidental load loss.

ABB DOES NOT TAKE ANY RESPONSIBILITY FOR DAMAGES CAUSED THROUGH INCORRECT USE OF THE UPS SYSTEM.



DANGER

DO NOT REMOVE ANY SCREWS FROM THE UPS SYSTEM OR FROM THE BATTERY CABINET: DANGER OF ELECTRICAL SHOCK.



DANGER

HIGH FAULT CURRENTS (LEAKAGE CURRENTS). BEFORE CONNECTING THE MAINS ENSURE THAT THE UPS IS EARTHED!



DANGER

DISPLAY A WARNING LABEL ON ALL PRIMARY POWER ISOLATORS INSTALLED AWAY FROM THE UPS AREA TO WARN ELECTRICAL MAINTENANCE PERSONNEL THAT THE CIRCUIT FEEDS A UPS.

MAKE SURE THAT WARNING LABEL CONTAINS THE FOLLOWING TEXT OR EQUIVALENT: "ISOLATE THE UPS (UNINTERRUPTIBLE POWER SUPPLY) BEFORE WORKING ON THIS CIRCUIT."

1.2 Environmental considerations

To operate the UPS with optimal efficiency, your installation site should meet the environmental parameters outlined in this user manual. Excessive amounts of dust or moisture in the operating environment may cause damage or lead to malfunction. The UPS should always be protected from the weather and sunshine. The operating environment must meet the weight, airflow, size and clearance requirements specified in the technical datasheet.

Under no circumstances should the UPS be installed in an airtight room, in the presence of flammable gases, or in an environment exceeding the environmental requirements specified below. An ambient temperature of +20°C to +25°C is recommended to achieve a long life of the UPS and batteries. The cooling air entering the UPS must not exceed +40 °C and the humidity should be below 95 percent (non-condensing).

1.3 Declaration of safety conformity and CE marking

The **PowerValue 11 RT G2 1-3 kVA** is designed, manufactured and commercialized in accordance with the **EN ISO 9001** standard relating to quality management systems.

These products conform with the following directives:

- 2014/35/EU Low voltage directive
- 2014/30/EU Electromagnetic Compatibility directive (EMC)
- 2011/65/EU Restriction of the use of certain hazardous substances (RoHS) directive



WARNING

THIS IS A CATEGORY C2 UPS PRODUCT. IN A RESIDENTIAL ENVIRONMENT, THIS PRODUCT MAY CAUSE RADIO INTERFERENCE, IN WHICH CASE THE USER MAY BE REQUIRED TO TAKE ADDITIONAL MEASURES.

These products also meet the following product standards:

Table 1: Standards

	Product Standards
ESD	IEC 61000-4-2 Level 3
Low Frequency Signals	IEC 61000-2-2 Disturbing Voltage:10V
RS	IEC61000-4-3 Level 3
EFT	IEC 61000-4-4 Level 4
Surge	IEC 61000-4-5 Level 4
CS	IEC 61000-4-6 Level 3
Power Frequency Magnetic Field Immunity	IEC 61000-4-8 Level 4
Conducted	IEC 62040-2 Category C2
Radiated	IEC 62040-2 Category C2
Performance classification	VFI-SS-III
Safety	IEC 62040-1:2008+A1+2013
Transportation	IEC 60068-2-31 IEC 60068-2-64 IEC 60068-2-27

1.4 Inquiries

Inquiries regarding the UPS should be addressed to the local ABB office or agent authorized by ABB. Note the type code and the serial number of the equipment before

contacting ABB or authorized agent. The serial number is shown on the nameplate of the product. For further information on troubleshooting, see Chapter 6.

1.5 Operation



WARNING

DO NOT DISCONNECT THE MAINS CABLE FROM THE UPS OR THE BUILDING WIRING SOCKET DURING OPERATION AS THIS REMOVES THE GROUND FROM THE UPS AND ALL CONNECTED LOADS.



NOTE

PRESS THE OFF BUTTON TO FULLY DISCONNECT THE UPS. ENSURE THE UPS IS ON BYPASS OR ON STANDBY MODE BEFORE DISCONNECTING IT FROM THE MAINS.



NOTE

TO REDUCE THE RISK OF FIRE, CONNECT THE UPS TO A CIRCUIT PROVIDED WITH BRANCH CIRCUIT OVERCURRENT PROTECTION WITH AN AMPERE RATING IN ACCORDANCE WITH THE IEC/EN 60934 STANDARD OR YOUR LOCAL ELECTRICAL CODE.

SEE TECHNICAL SPECIFICATIONS FOR RECOMMENDATIONS.



WARNING

INDISCRIMINATE OPERATION OF SWITCHES MAY CAUSE OUTPUT LOSS OR DAMAGE TO EQUIPMENT.



WARNING

NEVER DISPOSE OF BATTERIES IN A FIRE AS THEY MAY EXPLODE.



WARNING

DO NOT OPEN OR DAMAGE THE BATTERIES.



WARNING

RELEASED ELECTROLYTE IS HARMFUL TO THE SKIN AND EYES.

2 Maintenance



DANGER

TO PREVENT RISK OF ELECTRIC SHOCK, ONLY QUALIFIED PERSONNEL MAY REMOVE THE UPS COVER



DANGER

TO PREVENT RISK OF SHOCKS AND RISK OF FAILURE DO NOT CUT, REWORK OR MANIPULATE THE MATERIAL DELIVERED WITH THE UPS

PowerValue 11 RT G2 1-3 kVA UPS requires only minimal maintenance.

Charge the UPS regularly to maximize the expected life of the battery. When connected to mains power, the UPS charges the batteries and prevents the batteries from overcharging and over-discharging.

- Replace the batteries when the battery service life has been exceeded (around three to five years at 25 °C ambient temperature). Contact your local ABB or an agent authorized by ABB for replacements.
- Charge the UPS once every four to six months if it is not used regularly.
- In high-temperature regions, charge and discharge the battery every two months. The standard charging time should be at least 12 hours.
- Replace the battery when the discharge time is less than 50 percent of specified after fully charging. Check the battery connection or contact your local dealer to order a new battery.



DANGER

SERVICING OF BATTERIES INVOLVES ENERGY AND SHOCK HAZARD AND SHOULD BE PERFORMED BY PERSONNEL KNOWLEDGEABLE ABOUT BATTERIES AND REQUIRED PRECAUTIONS



WARNING

DO NOT DISPOSE OF BATTERIES IN A FIRE. THE BATTERIES MAY EXPLODE



WARNING

DO NOT OPEN OR MUTILATE BATTERIES. RELEASED ELECTROLYTE IS HARMFUL TO THE SKIN AND EYES. IT MAY BE TOXIC



DANGER

COMPONENTS INSIDE THE UPS ARE CONNECTED TO THE BATTERY EVEN WHEN THE UPS IS DISCONNECTED FROM THE MAINS POWER SUPPLY.



DANGER

DISCONNECT THE BATTERIES BEFORE CARRYING OUT ANY KIND OF SERVICE AND/OR MAINTENANCE. VERIFY THAT NO CURRENT IS PRESENT, AND NO HAZARDOUS VOLTAGE EXISTS IN THE CAPACITOR OR BUS CAPACITOR TERMINALS.



DANGER

THE BATTERY CIRCUIT IS NOT ISOLATED FROM THE INPUT VOLTAGE. HAZARDOUS VOLTAGES MAY OCCUR BETWEEN THE BATTERY TERMINALS AND THE GROUND. VERIFY THAT NO VOLTAGE IS PRESENT BEFORE SERVICING.



DANGER

A BATTERY CAN PRESENT A RISK OF ELECTRICAL SHOCK AND HIGH SHORT-CIRCUIT CURRENT. THE FOLLOWING PRECAUTIONS SHOULD BE OBSERVED WHEN WORKING ON BATTERIES:

- REMOVE WATCHES, RINGS OR OTHER METAL OBJECTS
- MAKE USE OF PROPER PPE (PERSONAL PROTECTION EQUIPMENT) AS PER LOCAL POLICIES AND RULES
 - WEAR FLAME/ARC RESISTANT WHOLE BODY CLOTHING
 - WEAR SUITABLE VOLTAGE RATED GLOVES
 - USE SAFETY DIELECTRIC FOOTWEAR
 - WEAR ARC FLASH FACE SHIELD
 - USE VOLTAGE RATED TOOLS
- DO NOT LAY TOOLS OR METAL PARTS ON TOP OF BATTERIES
- DISCONNECT THE CHARGING SOURCE PRIOR TO CONNECTING OR DISCONNECTING BATTERY TERMINALS.



WARNING

WHEN REPLACING BATTERIES, REPLACE WITH THE SAME TYPE AND NUMBER OF BATTERIES OR BATTERY PACKS



WARNING

REPLACE FUSES ONLY WITH FUSES OF THE SAME TYPE AND OF THE SAME AMPERAGE TO AVOID FIRE HAZARDS.

2.1 UPS disposal and recycling

2.1.1 For professional users in the European Union

THE CROSSED-OUT WHEELED BIN SYMBOL ON THE PRODUCT(S) AND / OR ACCOMPANYING DOCUMENTS MEANS THAT USED ELECTRICAL AND ELECTRONIC EQUIPMENT (WEEE) SHOULD NOT BE MIXED WITH GENERAL HOUSEHOLD WASTE.



IF YOU WISH TO DISCARD ELECTRICAL AND ELECTRONIC EQUIPMENT (EEE), PLEASE CONTACT YOUR DEALER OR SUPPLIER FOR FURTHER INFORMATION.

DISPOSING OF THIS PRODUCT CORRECTLY WILL HELP SAVE VALUABLE RESOURCES AND PREVENT ANY POTENTIAL NEGATIVE EFFECTS ON HUMAN HEALTH AND THE ENVIRONMENT, WHICH COULD OTHERWISE ARISE FROM INAPPROPRIATE WASTE HANDLING.

2.1.2 For disposal in countries outside of the European Union

THE CROSSED-OUT WHEELED BIN SYMBOL IS ONLY VALID IN THE EUROPEAN UNION (EU) AND MEANS THAT USED ELECTRICAL AND ELECTRONIC EQUIPMENT (WEEE) SHOULD NOT BE MIXED WITH GENERAL HOUSEHOLD WASTE.



IF YOU WISH TO DISCARD THIS PRODUCT PLEASE CONTACT YOUR LOCAL AUTHORITIES OR DEALER AND ASK FOR THE CORRECT METHOD OF DISPOSAL.

DISPOSING OF THIS PRODUCT CORRECTLY WILL HELP SAVE VALUABLE RESOURCES AND PREVENT ANY POTENTIAL NEGATIVE EFFECTS ON HUMAN HEALTH AND THE ENVIRONMENT, WHICH COULD OTHERWISE ARISE FROM INAPPROPRIATE WASTE HANDLING.

3 Installation

3.1 Delivery, transportation, positioning and storage

3.1.1 Receipt of the UPS and visual inspection

When receiving the UPS, carefully examine the packing container and the UPS for any signs of physical damage.



WARNING

IN CASE OF RECOGNIZABLE DAMAGE: DO NOT CONNECT ANY VOLTAGE TO THE UNIT /DO NOT PUT THE UNIT INTO OPERATION

The packing container of the UPS protects it from mechanical and environmental damage. To increase protection, the UPS is wrapped in a plastic sheet. Keep the packaging for later re-use.

3.1.2 Unpacking list

After examining the package, open the box and check the following items are included:

- 1 x PowerValue 11 RT G2 UPS
- 1 X USB with complete documentation in 5 languages
- Multi-language quick installation guide
- 2 x UPS stands (support)
- 8 x M4 hex screw with spring washer (UPS stands)
- 8 x M4 pan washer screw (UPS stands)
- 8 x M4 flat screw (for rack mount ear)
- Rack-mount ear
- 1 x Schuko-IEC C13 cable (only for 1KB/1KS)
- 1 x Schuko-IEC C19 cable (only for 2KB/2KS/3KB)
- Input power cord (Australian models - AU/NZ type plug)
- 1 x IEC C13-C14 cable
- 1 x IEC C19-C20 cable (only for 3KB/3KS)
- 1 x external battery cable (only for S models)
- 1 x USB cable
- 1 x M16 cable gland (only for 3KS model)
- 1 x fixing plate for battery cable

Rack-mounting accessories (full rack-mounting kit can be purchased separately):

- 2 x Rack-mount ear
- 8 x M4 screw (rack-mount ears)

Examine the UPS for any signs of damage and ensure that the received UPS corresponds to the material indicated in the delivery note. Notify your carrier or supplier immediately in case of any damage.

3.1.3 Operation of UPS

The UPS system contains no user-serviceable parts. If the battery service life (3~5 years at 25°C ambient temperature) has been exceeded, the batteries must be replaced. In this case, please contact your dealer.



Be sure to deliver the spent battery to a recycling facility or ship it to your dealer in the replacement battery packing material.

3.1.4 Storage of UPS

Before storing, charge the UPS 5 hours. Store the UPS covered and upright in a cool, dry location. During storage, recharge the battery in accordance with the following table:

Storage temperature	Recharge frequency	Charging duration
-25°C - 40°C	Every 3 months	1-2 hours
40°C - 45°C	Every 2 months	1-2 hours

3.2 Site planning and positioning

3.2.1-1:
Ear bracket

3.2.1-2:
Rack rails

3.2.1-3:
Rack-mount installation



WARNING

- MAKE SURE THE MAINS SUPPLY AND THE TOTAL LOAD DEMAND ARE WITHIN UPS SPECIFICATIONS
- THE UPS MUST BE POWERED FROM A SINGLE-PHASE GROUNDED WALL OUTLET, PROTECTED BY OVERCURRENT DEVICES ACCORDING TO LOCAL WIRING RULES (NOT APPLICABLE FOR POWERVALUE 11 RT G2 3KVA S)
- THE PLUG ON THE POWER SUPPLY CORD IS INTENDED TO SERVE AS THE DISCONNECT DEVICE, THE MAINS SOCKET OUTLET THAT SUPPLIES THE UPS SHALL BE INSTALLED NEAR THE UPS AND SHALL BE EASILY ACCESSIBLE (NOT APPLICABLE FOR POWERVALUE 11 RT G2 3KVA S)
- AFTER REMOVING COVERS OVER BATTERY TERMINAL, STORE THEM SAFELY FOR FUTURE NEED. REMOVE SUCH COVERS ONLY IF IT IS INTENDED TO ATTACH A CONNECTOR TO A TERMINAL.

3.2.1 Planning before the installation

To ensure a long service life, install the unit in a position where any danger to the UPS is minimized:

- Install the UPS indoors.
- Leave enough space on each side of the cabinet to allow cooling airflow and ensure that the circulation of air to the ventilation slits is not obstructed.
- Avoid excessively high temperatures and excessive moisture.
- Make sure that the surface is solid and flat.

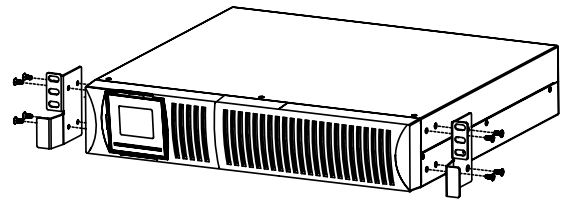

3.2.1-1

3.2.2 Positioning

PowerValue 11 RT G2 can be mounted in a rack or installed in a standalone configuration.



WARNING

WATER CONDENSATION MAY OCCUR IF THE UPS IS UNPACKED IN A VERY LOW TEMPERATURE. TO AVOID HAZARDS AND RISK OF ELECTRIC SHOCK, WAIT UNTIL THE UPS IS FULLY DRY BOTH INSIDE AND OUTSIDE BEFORE INSTALLING/USING THE UPS.



WARNING

HANDLE THE UPS CAREFULLY TO AVOID INJURY FROM FALLING OBJECTS REFER TO THE TECHNICAL DATA SHEET FOR UPS WEIGHTS.

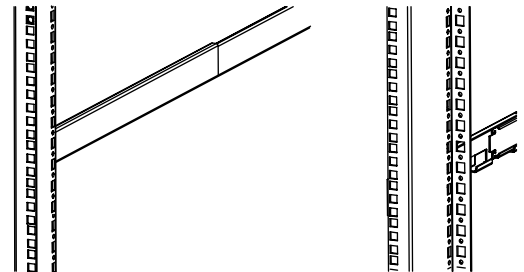

3.2.1-2

3.2.3 Rack-mount installation



WARNING

TO AVOID INJURY FROM FALLING OBJECTS MAKE SURE THAT THE RACK CABINET CAN ACCEPT THE UPS WEIGHT BEFORE INSTALLING IT, INCLUDING PROVISIONS FOR FIXING THE UPS BY SCREW.

IT IS RECOMMENDED TO INSTALL THE BATTERY STARTING FROM THE BOTTOM OF THE RACK

3.2.3.1 UPS

Note that you need a rack-mounting kit (purchased separately) for this operation. This procedure is suitable for 19-inch rack cabinet installation with a minimum depth of 800 mm. Identify the final position and keep 2U spacing for this installation.

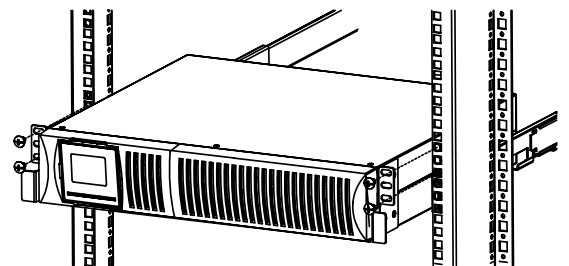

3.2.1-3

—
3.2.3.2-1:
Battery module
connection

—
3.2.3.2-2:
Battery module
connection

1. Install the ear bracket onto the unit using the M4 flathead screws (figure 3.2.1-1).
2. Slide the unit into the rail kit and make sure to tighten the rack-mounting screw (figure 3.2.1 -3).
3. After installing the UPS into the rack, proceed with the connection of the load to the UPS. Make sure the load devices are turned off before plugging them into the output receptacles.

i
NOTE

UP TO FOUR EXTERNAL BATTERY ENCLOSURES CAN BE CONNECTED TO THE UPS IN THE SAME WAY AS SHOWN ABOVE.

3.2.3.2 External battery modules



WARNING

DO NOT PILE UPS AND EBM ENCLOSURES, THEY MIGHT FALL OVER. THE PICTURE BELOW REPRESENTS JUST A SIMPLIFIED CONNECTION DIAGRAM.

Identify the final position and keep 2U spacing for this installation; it is recommended that this spacing is provided below the UPS.

1. Install the ear bracket onto the unit with the flathead M4 screw. (figure 3.2.1-1).
2. Slide the unit into the rail kit and make sure to tighten the rack-mounting screw (figure 3.2.1-3).
3. Connect the EBM to the UPS with the battery power cable (figure 3.2.3.2-1).
4. Install fixing plate to fix battery cable (figure 3.2.3.2-2)

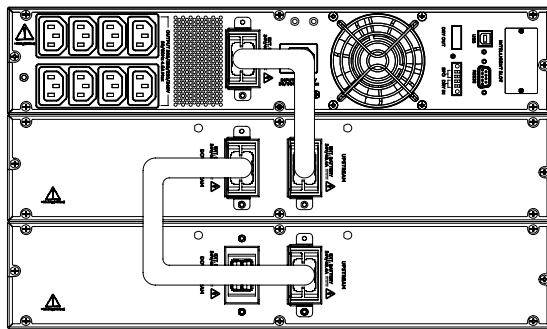

—
3.2.3.2-1

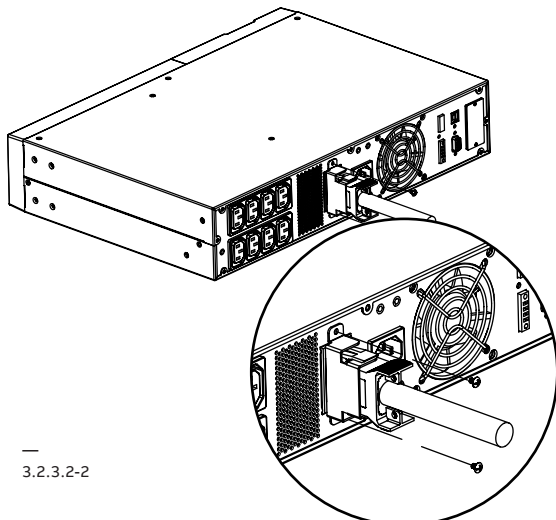

—
3.2.3.2-2

—
3.2.4.1-1:
Stabilizer bracket for
external battery module

—
3.2.4.2-1:
Stabilizer bracket for
external battery module

3.2.4 Standalone / tower installation



WARNING

TO AVOID INJURY FROM TRIPPING, PLACE THE UPS AND EBM ENCLOSURES AND RUN CABLES WHERE THEY DO NOT POSE A TRIP HAZARD.



DANGER

CIRCUITS BEHIND DISPLAY LCD CAN CREATE RISK OF ELECTRIC SHOCK IF EXPOSED. DO NOT TRY TO ROTATE THE DISPLAY BY USING HANDS OR TOOL. PLEASE REFER TO CHAPTER 4.6 TO ROTATE THE DISPLAY.

3.2.4.1 UPS

1. Set up the stabilizer bracket then put the unit into the stabilizer bracket. (figure 3.2.4.1-1).



NOTE

PLEASE INSTALL THE 4 SCREWS TO ENSURE THAT THE UNIT IS CORRECTLY PLACED IN STANDALONE/TOWER POSITION

3.2.4.2 External battery modules

1. Set up the extension plate as below and install it on the UPS stabilizer bracket.
2. Install the UPS and EBM individually into the stabilizer bracket.
3. Connect to the UPS with the battery power cable (refer to rack position installation).



NOTE

IT IS RECOMMENDED THAT THIS UNIT BE INSTALLED TO UPS RIGHT HAND SIDE. IF INSTALLING AN ADDITIONAL UNIT, PLACE IT NEXT TO THE PREVIOUS UNIT.

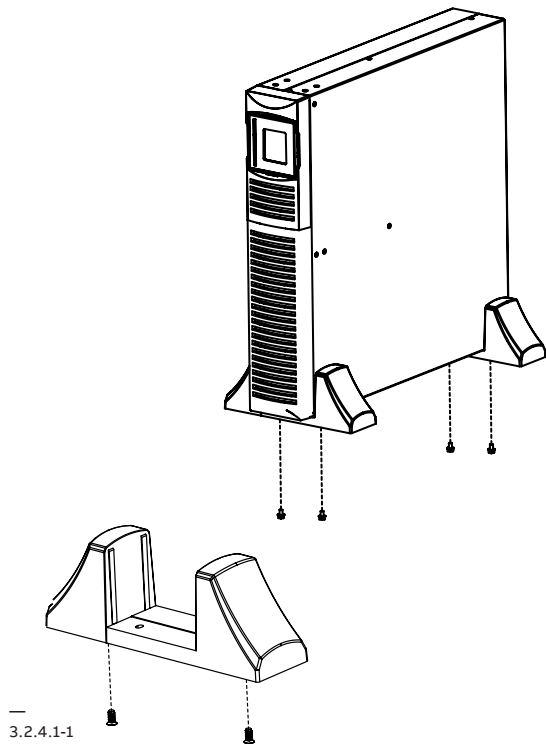

3.2.4.1-1

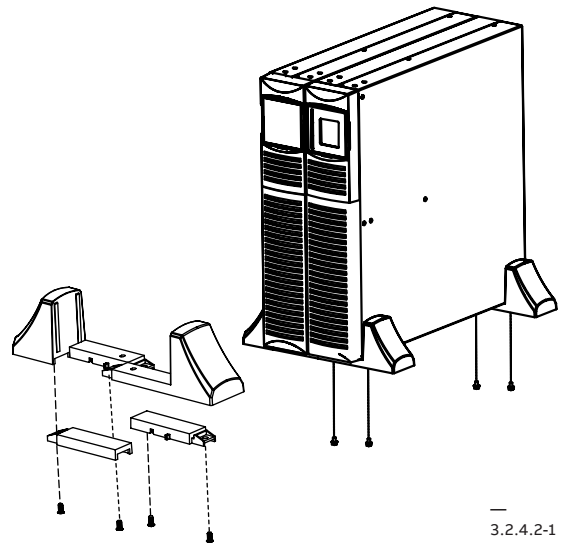

3.2.4.2-1

—
3.2.5-1:
Terminal cover hole

—
3.2.5-2:
Spare cable glands

—
3.2.5-3:
PVC single cord

—
3.2.5-4:
Wires connection

—
3.2.5-5:
Cover back

3.2.5 PowerValue 11 RT G2 3kVA S installation



WARNING

THE WIRING INSTALLATION SHALL BE PERFORMED BY QUALIFIED PERSONNEL ONLY.

1. The cover and cable gland must be installed over input terminals and input cables to prevent risk of electric shock during standalone/tower use.
2. Push in the hole of terminal cover.

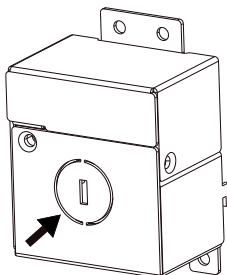

—
3.2.5-1

3. Separate pressure dome and lock nut, assemble the provided spare cable glands on the two sides of terminal cover and screw it tightly.

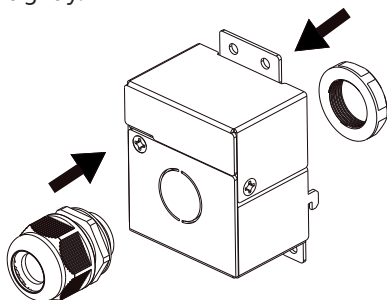

—
3.2.5-2

4. Pass the input cable through the gland assembly; use PVC single cord, 3G, 2.5 mm², double-insulated, rated 300 V (IEC 60227-1). The overall diameter of the power supply cord must be approximately 10.5 mm to allow reliable clamping from cable gland, to prevent failure from arcing and electric shock.

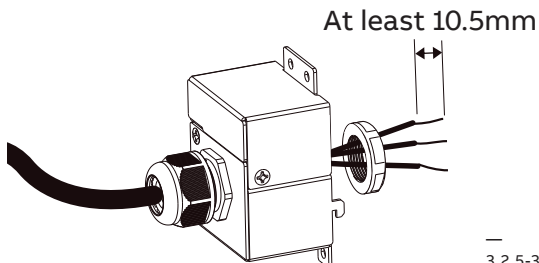

—
3.2.5-3

5. Connect three wires according to the polarities indicated on the terminal blocks. Be sure to connect ground first.
6. Put the terminal cover back on the UPS by fixing 4 screws.

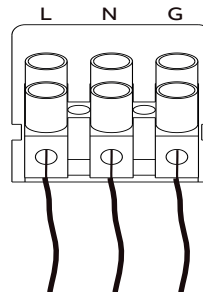

—
3.2.5-4

7. The UPS does not incorporate a disconnect device, that must be part of the building installation: UPS mains input shall be

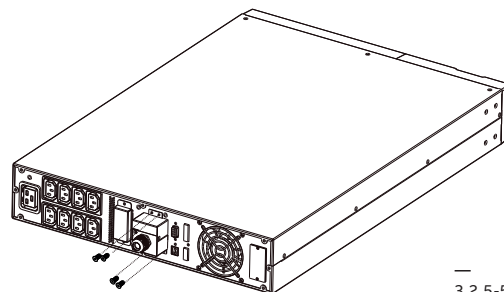

—
3.2.5-5

protected by an 2-pole overcurrent protection device according to IEC 60898-1 / IEC 60947-2 not exceeding 25 A.

i
NOTE

DURING BATTERY OPERATION UPS DISCONNECTS THE NEUTRAL

3.3 General characteristics

—
3.3.1-1:
PowerValue 11 RT
G2 front panel

3.3.1 UPS front panel

Figure 3.3.1-1 shows the front panel of the UPS.

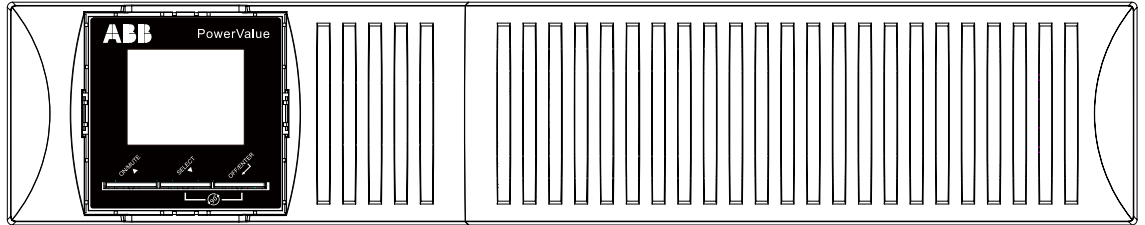

3.3.1-1

—
3.3.2-1:
PowerValue 11
RT G2 1kVA B/S
rear view

—
3.3.2-2:
PowerValue 11
RT G2 2kVA B/S
rear view

3.3.2 UPS rear panel

The figures below show the connectors and ports in the UPS and external battery module rear panel.

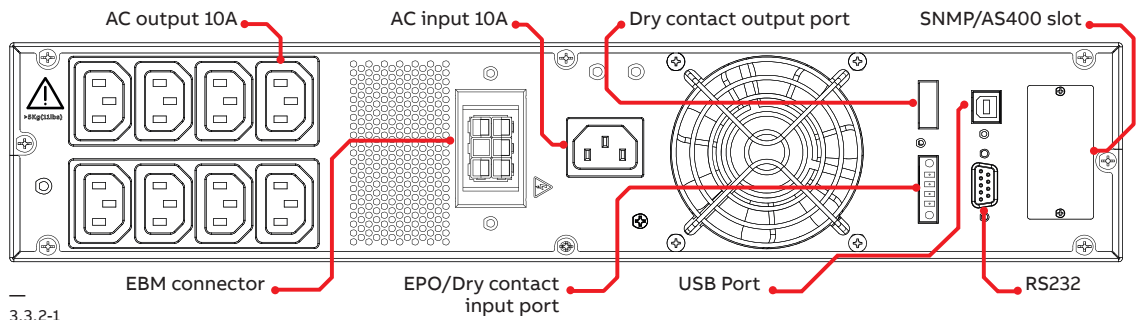

3.3.2-1

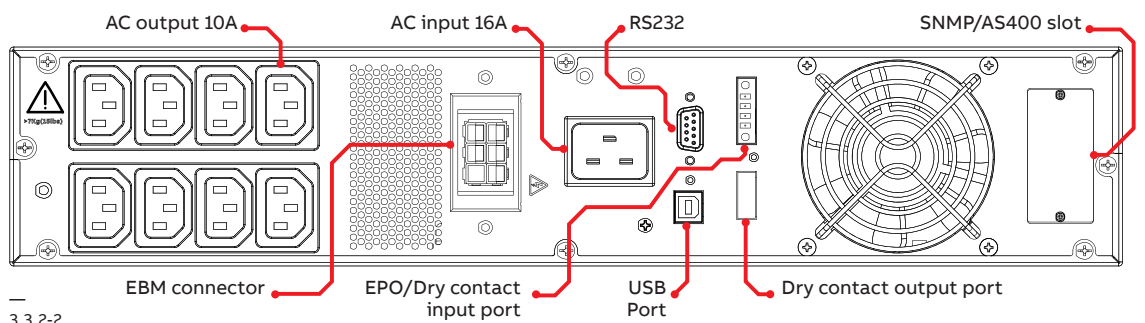

3.3.2-2

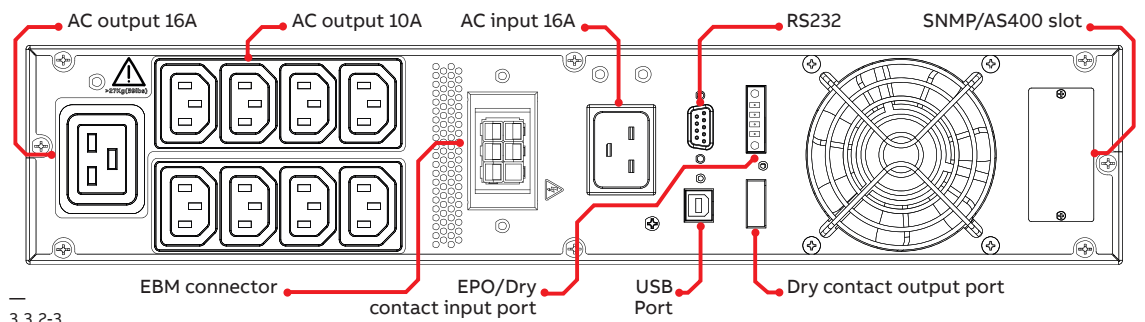

3.3.2-3

—
3.3.2-4:
PowerValue 11 RT G2
3kVA S rear view

—
3.3.2-5:
External battery
module rear view

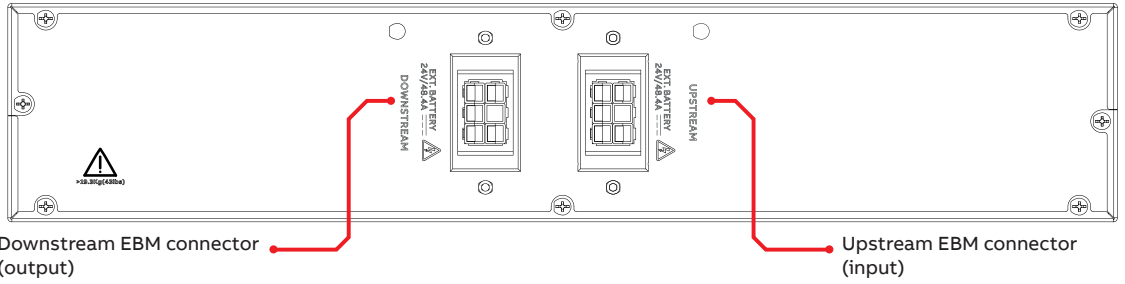
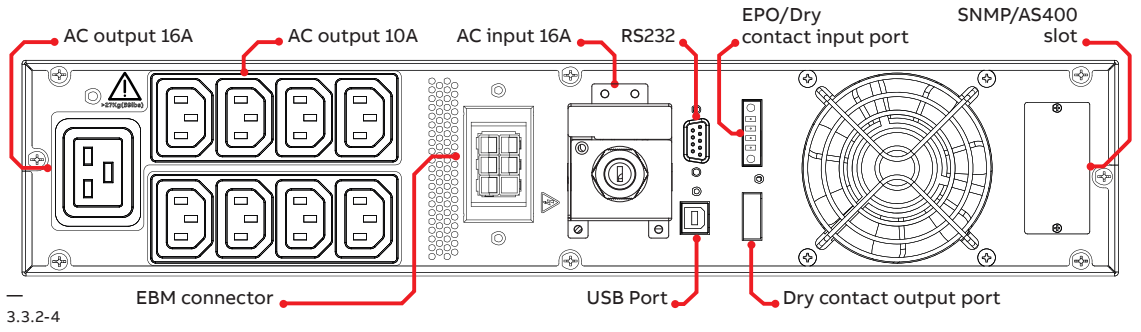

4 Operation

This chapter describes how the UPS is operated through the LCD.

The user can:

- Operate the LCD
- Start up and shut down the UPS (excluding the commissioning start up)
- Operate additional SNMP adapters and their software

4.1 Control panel

4.1-1:
Control panel

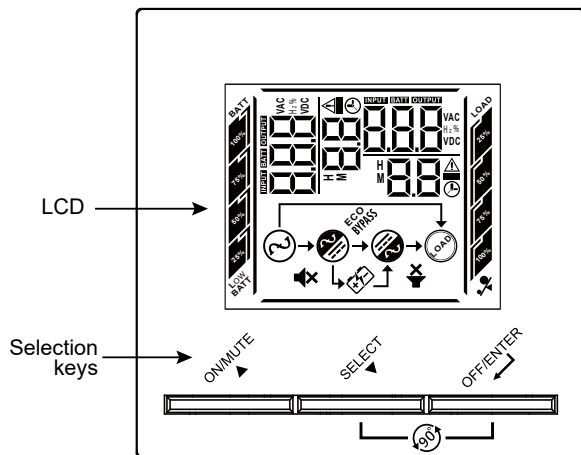

The user-friendly control panel has two parts:

- Selection keys
- Power management LCD (PMD)

4.1-1

4.1.1 Selection keys

Table 2: UPS selection keys

Button	Function	Illustration
	ON/Mute Button	<ul style="list-style-type: none"> • Turn on the UPS: Press and hold ON/Mute button for at least 2 seconds to turn on the UPS. • Mute the alarm: When the UPS is on battery mode, press and hold this button for at least 5 seconds to disable or enable the alarm system. Not applicable to situations when warnings or errors occur. • Up key: Press this button to display previous selection in UPS settings mode. • Switch to UPS self-test mode: Press and hold ON/Mute button for 5 seconds to enter UPS self-testing while in AC mode, ECO mode, or converter mode.
	OFF/Enter Button	<ul style="list-style-type: none"> • Turn off the UPS: Press and hold this button at least 2 seconds to turn off the UPS. UPS will be in standby mode under power normal or will transfer to bypass enable, if the bypass enable is set when this button is pressed. • Confirm selection key: Press this button to confirm selection in UPS settings mode.
	Select Button	<ul style="list-style-type: none"> • Switch LCD message: Press this button to change the LCD message for input voltage, input frequency, battery voltage, output voltage and output frequency. It will revert to default display after 10 s of no input. • Settings mode: Press and hold this button for 5 seconds to enter UPS settings mode when UPS is in standby mode or bypass mode. • Down key: Press this button to display next selection in UPS settings mode.
	ON/Mute + Select Button	<ul style="list-style-type: none"> • Switch to bypass mode: When the main power is normal, press ON/Mute and Select buttons simultaneously for 5 seconds. Then UPS will enter to bypass mode. This action will be ineffective when the input voltage is out of acceptable range.
	OFF/Enter + Select Button	<ul style="list-style-type: none"> • Switch LCD screen 90°: Press Off/Enter and select buttons simultaneously 5 second. The UPS LCD screen will rotate 90°.

4.1.2-1:
The default LCD

4.1.2 LCD

The LCD shows an overview of the status of the UPS:

- Input
- Output
- Battery
- Load parameters
- Working mode
- Frequency
- Bypass presence.

The LCD backlight automatically dims after two minutes of inactivity (except in cases of a UPS fault). Press any button to wake up the screen.

A buzzer indicates UPS status. Table 3 lists the buzzer status meanings.

Table 3: Definition of alarms

UPS condition	Buzzer status
Active fault	Continuous
Active warning	Beep every second
Battery	UPS on battery: Beep every 4 seconds Low battery: Buzzer beeps every second
Bypass	Beep every 10 minutes
Overload	Beep twice every second

When powering on, the LCD shows the UPS status. The UPS will also return to this default screen when no buttons have been pressed for 15 minutes.

The status screen shows the following information:

- Status summary, including operating mode and load information
- Alarm status, if present (including fault and warning information)
- Battery and charger status (including battery voltage, charge level and charger status)
- Current runtime information

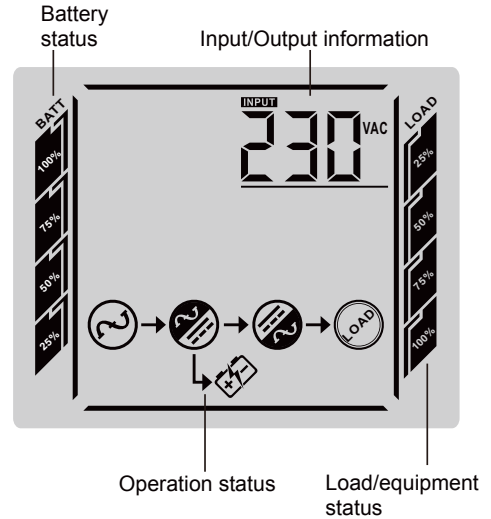





4.1.2-1

For more information on how to use the LCD, see Chapter 4.6 and 4.7.

4.2 Operating mode

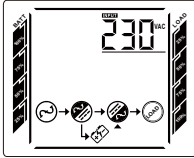
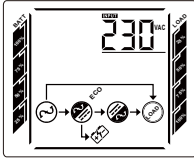
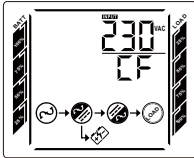
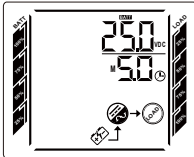
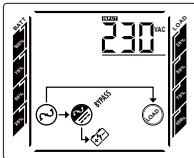
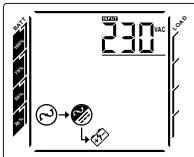
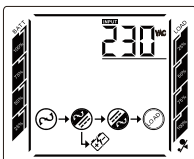
The following table describes the UPS status information:

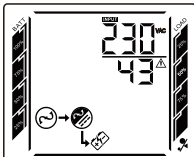
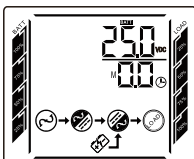
Table 4: Symbols in operating mode

Status	LCD Screen	Description
Online mode		When the input voltage is within acceptable range, UPS will provide pure and stable AC power to output. The UPS will also charge the battery in online mode.
ECO mode		Energy saving mode: When the input voltage is within voltage regulation range, UPS will bypass voltage to output for energy saving.
Frequency converter mode		When input frequency is within 40 Hz to 70 Hz, the UPS can be set at a constant output frequency, 50 Hz or 60 Hz. The UPS will still charge battery under this mode.
Battery mode		When the input voltage is beyond the acceptable range or power failure and alarm is sounding every 4 second, UPS will backup power from battery.
Bypass mode		When input voltage is within acceptable range but UPS is overloaded, UPS will enter bypass mode or bypass mode can be set from front panel. Alarm sounds every 10 second.
Standby mode		UPS is powered off and no output supply power, but still can charge batteries.
Overload warning		When the UPS is in overload, an alarm sounds twice every second.  will flash. Disconnect unnecessary loads one by one to decrease the load. The load should be lower than 90 percent of its nominal power capacity in order to stop alarming.
Overload fault		When the UPS is in overload fault, an alarm sounds continuously. Overload icon will be on. At this time, UPS will stop operation and there is no output power on receptacles. Please check chapter 6.Troubleshooting to solve this problem.
Battery test		UPS is performing a battery test.  will flash.

4.3 UPS start-up and shutdown



WARNING

SWITCH OFF THE CONNECTED LOADS BEFORE TURNING ON THE UPS. SWITCH ON THE LOADS ONE BY ONE AFTER THE UPS IS TURNED ON. SWITCH OFF ALL OF THE CONNECTED LOADS BEFORE TURNING OFF THE UPS.



NOTE

THE FIRST TIME THE UPS IS STARTED UP, IT MUST BE CONNECTED TO THE UTILITY.

4.3.1 UPS start-up

To start up the UPS with mains supply:

1. Check that all cables are securely and correctly connected.
2. Keep the power button pressed for longer than 1 second. The fans will activate and the UPS will load for a few seconds.
3. The UPS will perform a self-test and the LCD will show the default UPS status screen.



NOTE

BYPASS MODE IS ENABLED BY DEFAULT AND CAN BE CONFIGURED THROUGH THE USER'S SETTINGS (FOR MORE INFORMATION, SEE TABLE 6).

To start up the UPS without mains supply (cold start):

4. Check that all cables are securely and correctly connected.
5. Keep the power button pressed for longer than 1 second. The UPS will power on, the fans will activate and the LCD will turn on. The UPS will perform a self-test and show the default UPS status screen.
6. Keep the power button pressed for longer than 1 second. The alarm buzzer will sound for 1 second and the UPS will start up.
7. After a few seconds, the UPS transfers to battery mode. When the UPS is supplied with power from the mains, the UPS transfers to online mode without interrupting the UPS power output.

4.3.2 UPS shutdown

To shut down the UPS with mains supply:

1. If the UPS is working in bypass mode, go to step 3.
2. If the UPS is in online mode, keep the power button pressed for more than 3 seconds. The alarm buzzer will sound and the UPS will transfer to bypass mode.



DANGER

THE OUTPUT IS STILL ENERGIZED.

3. Disconnect the mains power supply. The display will shut down and the output voltage will be removed from the UPS output terminal.
4. If the bypass has been disabled via the Settings menu, keep the power button pressed for longer than 3 seconds to shut down the UPS. The unit will transfer from online to standby mode. Disconnect the input power cable and the display will shut down.

To shut down the UPS without mains supply:

1. To power off the UPS, keep the power on/off button pressed for more than 3 seconds. The alarm buzzer will sound for 3 seconds and the output power will be immediately cut off.
2. The display will shut down and the output voltage will be removed from the UPS output terminal.

4.4 LCD wordings index

The following table describes the UPS status information:

Table 5: Symbols in operating mode

Abbreviation	Display content	Meaning
ENA	ENR	Enable
DIS	dIS	Disable
ESC	ESC	Escape
HLS	HLS	High loss
LLS	LLS	Low loss
CF	CF	Converter
TP	tP	Temperature
CH	CH	Charger fail
FU	FU	Bypass frequency unstable
EE	EE	EEPROM error
TON	tON	Input dry contact: UPS turn on
TOF	tOF	Input dry contact: UPS turn off
MBS	3bS	Input dry contact: Maintain bypass
SAL	SAL	Output dry contact: Summary alarm
BTA	bTA	Output dry contact: Battery active
LBA	LbA	Output dry contact: Low battery active
UPN	UPN	Output dry contact: UPS normal
BSA	bSA	Output dry contact: Bypass active
CLR	CLr	Clear
RAC	rAC	Display type: Rack
TOE	tOE	Display type: Rower
ON	ON	Output receptacle on
OFF	OFF	Output receptacle off

4.5 LCD panel

Rack display

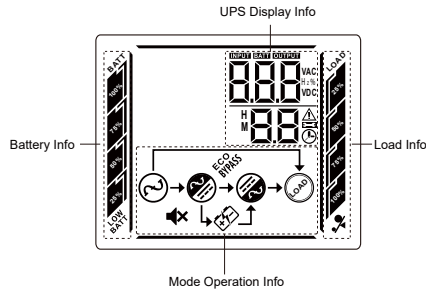

Tower display

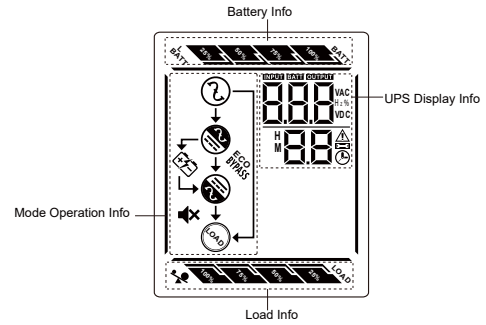

Table 6: Symbols in operating mode

Display	Function
	Indicates the remaining backup time in pie chart.
	Indicates the remaining backup time in numbers. H: hours, M: minute, S: second
	Indicates warning and fault.
	Indicates the warning and fault code. Code details are listed in section 3.5.
	Indicates that the UPS alarm is disabled.
	Indicates the input voltage, frequency, output voltage, battery voltage, output current, battery capacity, load percent, output power, positive bus voltage, negative bus voltage, temperature, output receptacle 1, output receptacle 2.
	Indicates the load level: 0-25%, 26-50%, 51-75%, and 76-100%.
	Indicates overload.
	Indicates the UPS is connected to the mains.
	Indicates the battery is working.
	Indicates the bypass circuit is working.
	Indicates the ECO mode is enabled.
	Indicates the Inverter circuit is working.
	Indicates the output is working.
	Indicates the battery level: 0-25%, 26-50%, 51-75%, and 76-100%.
	Indicates low battery level and low battery voltage.
	Indicates UPS is in settings mode.

4.6 LCD settings



WARNING

CHANGING UPS SETTINGS MIGHT ADVERSELY IMPACT THE LOAD SUPPLY OR LOAD FUNCTIONALITY. IT IS RECOMMENDED TO DISCONNECT THE LOAD BEFORE PROCEEDING

Press and hold select button for 5 seconds to enter UPS settings mode when UPS is in standby mode or bypass mode. Press and hold "Off/Enter" and "select" buttons for 5 seconds to switch LCD screen in rack or tower display.

Rack display

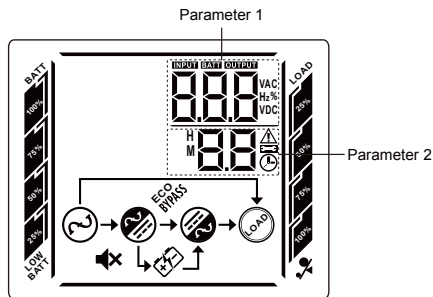

Tower display

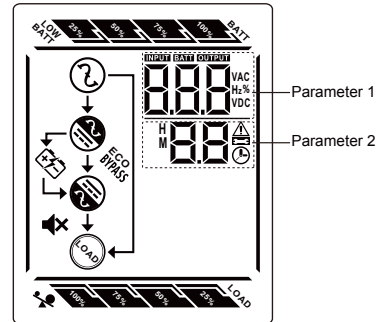

There are two parameters to set up the UPS.
 Parameter 1: For program alternatives. Refer to table below.
 Parameter 2: The settings options or values for each program.

01: Output voltage setting

Interface

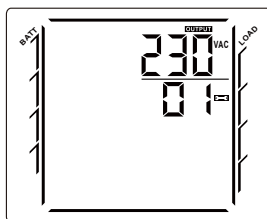

Settings

Output voltage

You may choose the following output voltage:

- 208: output voltage is 208 Vac
- 220: output voltage is 220 Vac
- 230: output voltage is 230 Vac (default)
- 240: output voltage is 240 Vac

02: Frequency converter enable/disable

Interface

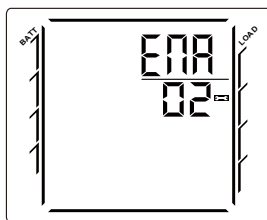

Settings

Parameter 1: Enable or disable converter mode. You may choose from the following two options:

- CF ENA: converter mode enable
- CF DIS: converter mode disable (default)

03: Output frequency settings

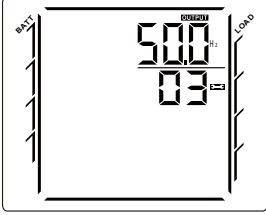
Interface	Settings
	<p>Parameter 1: Output frequency setting. You may set the initial frequency on battery mode: 50: output frequency is 50 Hz 60: output frequency is 60 Hz If converter mode is enabled, you may choose from the following output frequency: 50: output frequency is 50 Hz 60: output frequency is 60 Hz</p>

04: ECO enable/disable

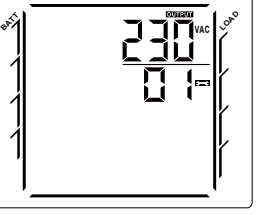
Interface	Settings
	<p>Parameter 1: Output voltage You may choose the following output voltage: 208: output voltage is 208 Vac 220: output voltage is 220 Vac 230: output voltage is 230 Vac (default) 240: output voltage is 240 Vac</p>

05: ECO voltage range settings

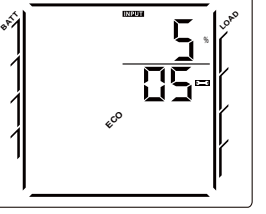
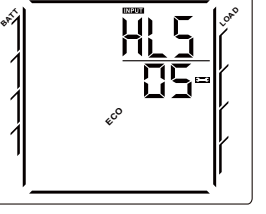
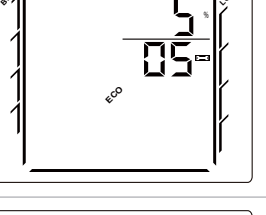
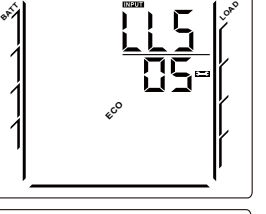
Interface	Settings
	<p>Parameter 1: Set the acceptable high voltage point and low voltage point for ECO mode by pressing Down key or Up key</p>
	<p>HLS: High loss voltage in ECO mode in parameter 1. The setting range in parameter 1 is from 5% to 10% of the nominal voltage. (Default: 5%)</p>
	<p>LLS: Low loss voltage in ECO mode in parameter 1. The setting range in parameter 1 is from -5% to -10% of the nominal voltage. (Default: -5%)</p>
	<p>LLS: Low loss voltage in ECO mode in parameter 1. The setting range in parameter 1 is from -5% to -10% of the nominal voltage. (Default: -5%)</p>

06: ECO frequency range settings

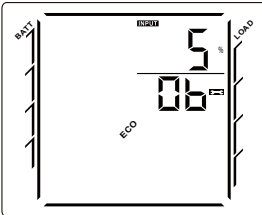
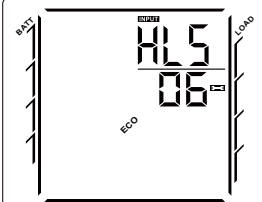
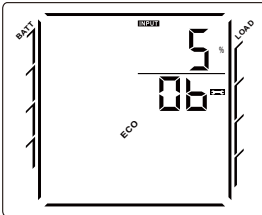
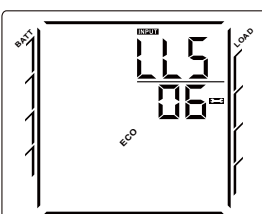
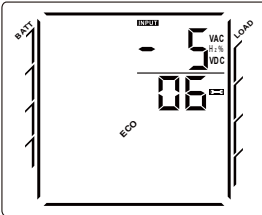
Interface	Settings
	<p>Parameter 1: Set the acceptable high frequency point and low frequency point for ECO mode by pressing Down key or Up key</p>
	<p>HLS: High loss frequency in ECO mode in parameter 1. The setting range in parameter 1 is from 5% to 10% of the nominal voltage. (Default: 5%)</p>
	
	<p>LLS: Low loss frequency in ECO mode in parameter 1. The setting range in parameter 1 is from -5% to -10% of the nominal voltage. (Default: -5%)</p>
	

07: Bypass enable/disable when UPS is off

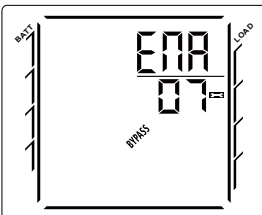
Interface	Settings
	<p>Parameter 1: Enable or disable Bypass function. You may choose the following two options: ENA: Bypass enable DIS: Bypass disable (Default)</p>

08: Bypass voltage range setting

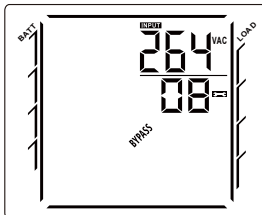
Interface	Settings
	<p>Parameter 1: Set the acceptable high voltage point and low voltage point for Bypass mode by pressing the Down key or Up key</p>

08: Bypass voltage range setting

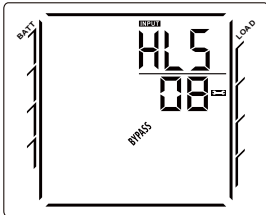
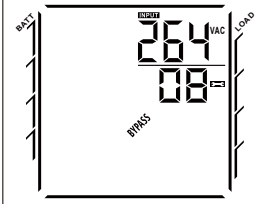
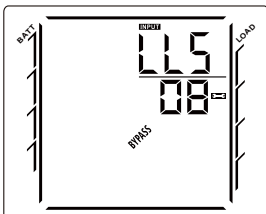
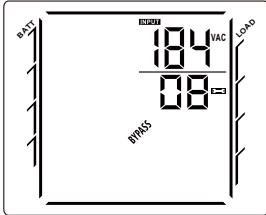
Interface	Settings
	<p>HLS: Bypass high voltage point 245-276: Sets the high voltage point in parameter 1 from 245 Vac to 276 Vac (Default: 264 Vac)</p>
	
	<p>LLS: Bypass low voltage point 120-215: Sets the low voltage point in parameter 1 from 120 Vac to 215 Vac (Default: 184 Vac)</p>
	

09: Bypass frequency range settings

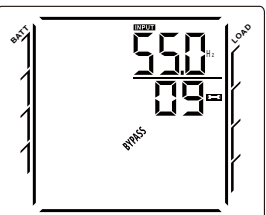
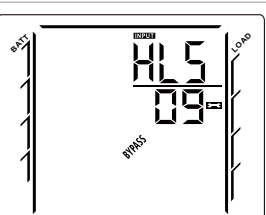
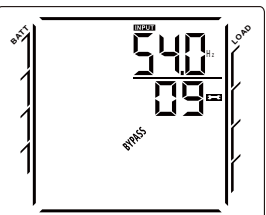
Interface	Settings
	<p>Parameter 1: Set the acceptable high frequency point and low voltage point for Bypass mode by pressing the Down key or Up key</p>
	<p>HLS: Bypass high frequency point 51.0-54.0: Sets the high frequency point in parameter 1 from 51.0 Hz to 54.0 Hz for 50 Hz system. (Default: 54.0 Hz) 61.0-64.0: Sets the high frequency point in parameter 1 from 61.0 Hz to 64.0 Hz for 60 Hz system. (Default: 64.0 Hz)</p>
	

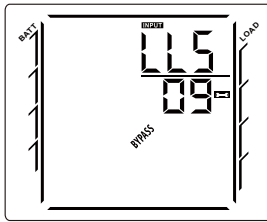
09: Bypass frequency range settings**Interface****Settings****LLS:** Bypass low frequency point

46.0-49.0: Sets the low frequency point in parameter 1 from 46.0 Hz to 49.0 Hz for 50 Hz system. (Default: 46.0 Hz)

56.0-59.0: Sets the low frequency point in parameter 1 from 56.0 Hz to 59.0 Hz for 60 Hz system. (Default: 56.0 Hz)

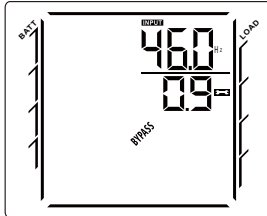
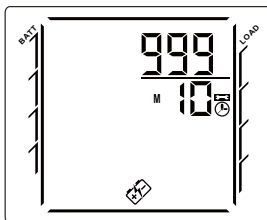
**10: Autonomy limitation settings****Interface****Settings****Parameter 1:** Set up backup time on battery mode for output receptacles.

0-999: Sets the backup time in minutes from 0-999 for output receptacles on battery mode

0: When setting as "0", the backup time will be only 10 seconds.

999: When setting as "999", the backup time setting will be disabled. (Default)



WARNING

IT IS MANDATORY SET BOTH PARAMETERS #11 AND #12 FOR THE CORRECT OPERATION OF THE SYSTEM.

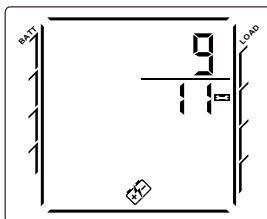
11: External battery Ah**Interface****Settings**

Set the total capacity in Ah of an external third party battery pack [no standard ABB External Battery Modules (EBM) are connected]

Allowed values are integer in the range 7-999 (Ah). The default value is "20" (Ah). Leave as default if connecting standard ABB External Battery Modules (EBM)

This setting will enable the UPS-model S to self-adjust the battery charger current, up to max 6 A; for the UPS-model B the battery charger current will be maintained at 1.5 A

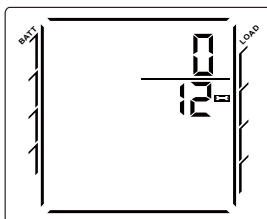
12: External battery module numbers**Interface****Settings**

Set the total number of standard ABB External Battery Modules [no third party external battery packs are connected]

Allowed values are integer in the range 0-9. The default value is "0". Set it as "1" if third party external battery packs are connected

This setting will enable the UPS-model S to self-adjust the battery charger current, up to max 6 A; for the UPS-model B the battery charger current will be maintained at 1.5 A

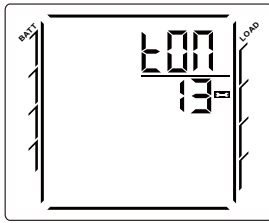
13: Input dry contact**Interface****Settings**

Parameter 1: Set input dry contact
DIS: Disable the function (default)
TON: UPS Turn On
TOF: UPS Turn Off
MBS: Maintain Bypass

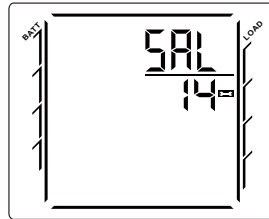
14: Output dry contact**Interface****Settings**

Parameter 1: Set output dry contact
SAL: Summary Alarm (default)
BTA: Battery Active
LBA: Low Battery
UPN: UPS Normal
BSA: Bypass Active

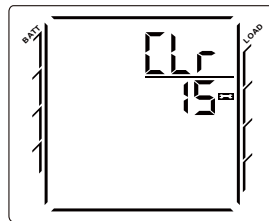
15: EPO warning clearance**Interface****Settings**

Parameter 1: Clear EPO warning
 EPO active, the UPS output is cut off. To recover the normal status, EPO connector must first be closed. Enter this menu to clear the status of EPO. The UPS will stop alarming and will recover in Bypass-mode
 Note that the UPS needs be turned on by manual operation

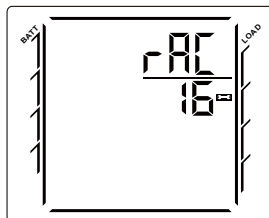
16: LCD type**Interface****Settings**

Parameter 1: Set LCD type.
RAC: The LCD type is rack (default)
TOE: The LCD type is tower

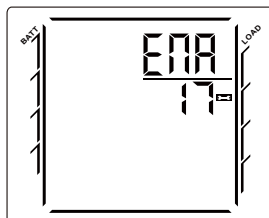
17: Audio alarm enable/disable**Interface****Settings**

Parameter 1: Set audio alarm
ENA: Audio alarm enable (default)
DIS: Audio alarm disable

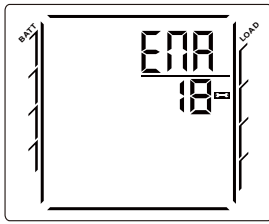
18: DC start enable/disable**Interface****Settings**

Parameter 1: Set DC start
ENA: DC start enable (default)
DIS: DC start disable

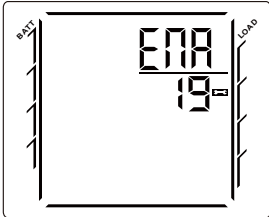
19: Ambient temperature warning enable/disable**Interface****Settings**

Parameter 1: Set ambient temperature warning
ENA: Ambient temperature warning enable (default)
DIS: Ambient temperature warning disable

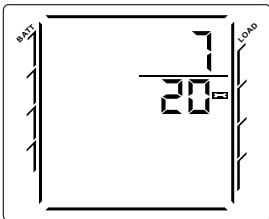
20: Automatic battery test**Interface****Setting**

Parameter 1: Set automatic battery test frequency. The setting range is 0-31 days.
 (Default: 7 days)

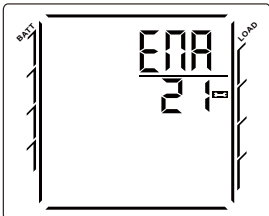
21: Auto Restart enable/disable**Interface****Settings**

Parameter 1: Set auto restart
ENA: Auto restart enable (default)
DIS: Auto restart disable

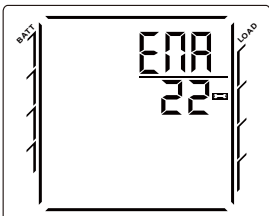
22: Automatic overload restart enable/disable**Interface****Settings**

Parameter 1: Set automatic overload restart
ENA: Automatic overload restart enable (default)
DIS: Automatic overload restart disable

23: Short circuit clearance

Interface

Settings

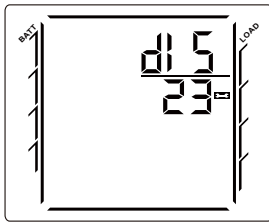

Parameter 1: Set short-circuit clearance
ENA: Short-circuit clearance enable
DIS: Shortcircuit clearance disable (default)

24: Output receptacles 1 on/off

Interface

Settings

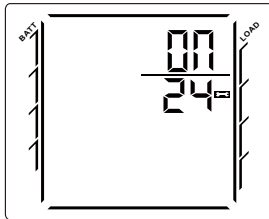

Parameter 1: Set output receptacle 1
ON: Output receptacle 1 On (default)
OFF: Output receptacle 1 Off

25: Output receptacles 2 on/off

Interface

Settings

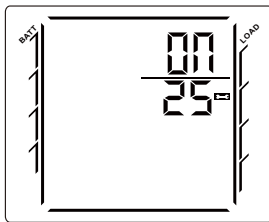

Parameter 1: Set output receptacle 2
ON: Output receptacle 2 On (default)
OFF: Output receptacle 2 Off

26: Site fault detection enable/disable

Interface

Settings

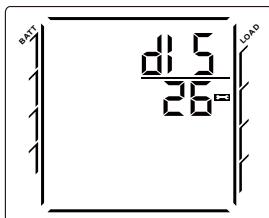

Parameter 1: Set site fault detection
ENA: Site fault detection enable
DIS: Site fault detection disable (default)

00: Exit settings

Interface

Setting

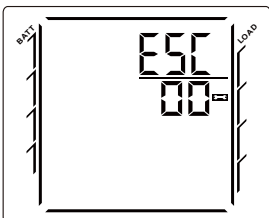

Parameter 1: Exit settings.

4.7 LCD measurement functions

4.7-1:
Display measurement functions

Use the "Select" button to navigate the display screen. When the UPS starts up, the display is in the default UPS status summary screen.

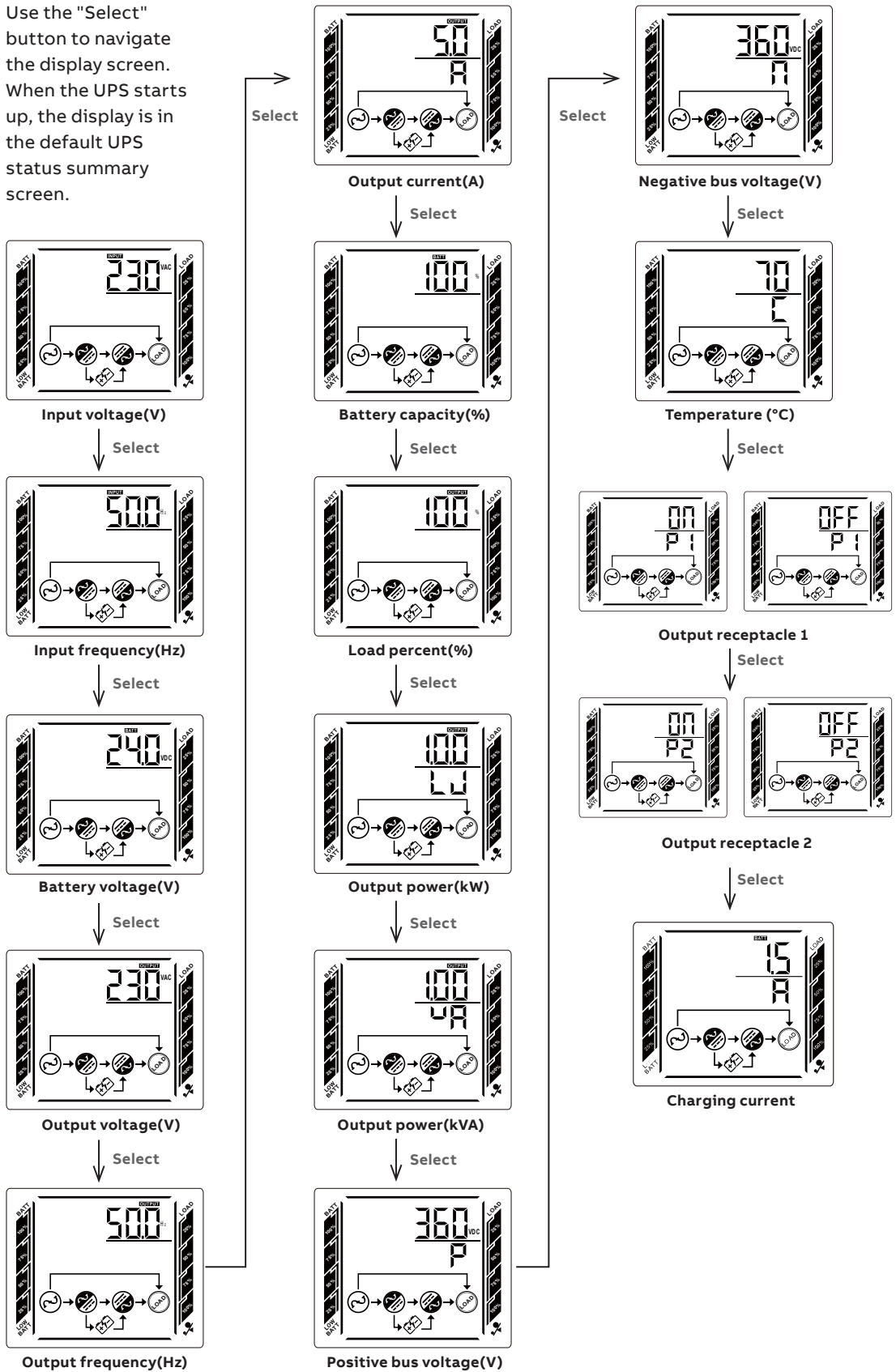

5 Battery replacement

5-1: Front panel removal

5-2: Battery plug disconnection

5-3: Battery cover removal

5-4: Batteries replacement

5-5: Battery cover insertion

5-6: Battery plug connection

5-7: Front panel insertion



WARNING

PLEASE REFER TO CHAPTER 2 FOR SAFETY INSTRUCTIONS.

Please read the following instructions to perform a correct battery replacement:

1. Remove the front panel.

5-1

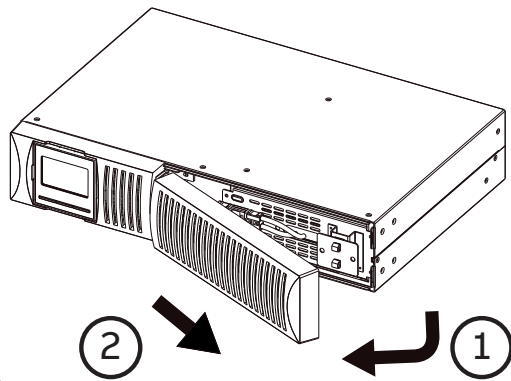

2. Disconnect the battery plug.

5-2

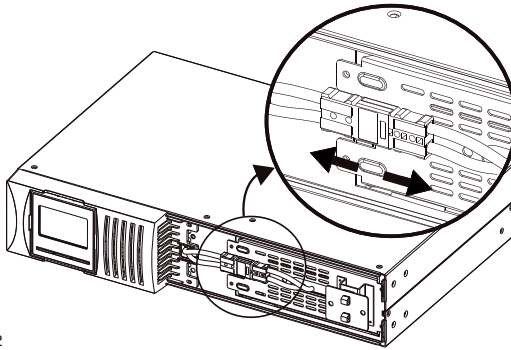

3. Take off the front battery cover by removing the 4 screws.

5-3

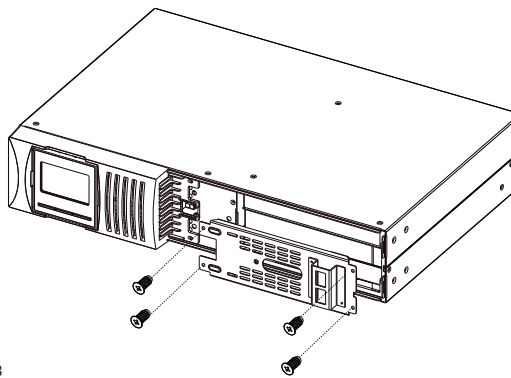

4. Extract the battery tray from the UPS and replace the batteries.
5. Reinsert the battery tray with the replaced batteries back into the original location

5-4

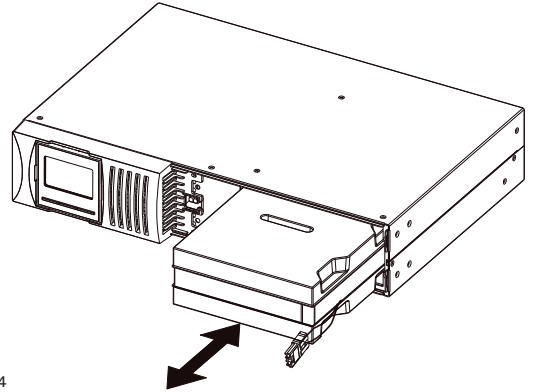

6. Tightly secure the 4 screws to lock back the battery cover to the unit.

5-5

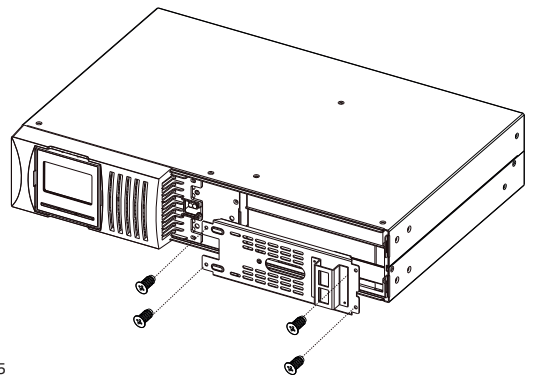

7. Reconnect the battery plug.

5-6

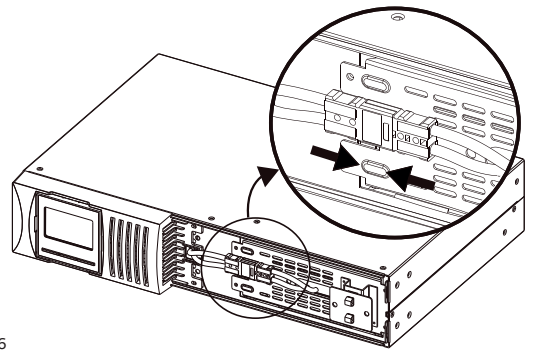

8. Reassemble the front panel back to conclude the battery replacement.

5-7

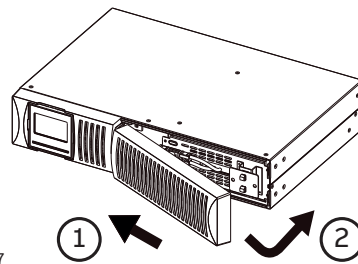

6 Communication

A USB and an RS-232 port are available to enable communication between the UPS and a remote computer/ station. Only one communication port can be active at a time and priority is given to the USB port.

Once the communication cable is installed, the power management software can exchange information with the UPS. The software collects information from the UPS and indicates the status of the device, the power quality of the mains and the battery autonomy of the units.

If there is a power failure and a predicted shutdown of the UPS due to low battery autonomies, the monitoring system can save the load data and initiate shutdown of the equipment connected to the UPS.



NOTE

CABLES LENGTHS SHALL NOT EXCEED 10 M

KEEP ROUTING OF COMMUNICATION CABLES SEPARATED FROM MAINS SUPPLY AC AND DC CABLES

6.1 RS-232 port

6.1-1:
RS-232 Communication
Port (DB-9 Connector)

The UPS has an RS-232 port for UPS monitoring, control and firmware updates. To establish communication between the UPS and a computer, connect one end of the serial communication cable to the RS-232 port on the UPS and the other end to the RS-232 port of a computer.

The cable pins for the RS-232 communication port are described in Figure 6.1-1 and Table 7.

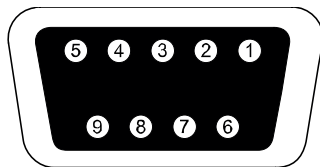

6.1-1

Table 7: Communication port pin assignment

PIN	Signal Name	Function	Direction from UPS
2	TxD	Transmit to external device	Out
3	RxD	Receive from external device	In
5	GND	Signal common	--

6.2 USB port

The UPS can communicate with USB-compliant computers that run power management software. To establish communication between the UPS and a computer, connect the USB cable to the USB port on the UPS. Connect the other end of the cable to the USB port on a computer.

6.3 Emergency power off

6.3-1:
EPO (Emergency power off)

6.3.2-1:
Dry IN & OUT connector

The EPO connector can be used to block the output of the UPS in case of an emergency. The EPO connector can be configured as Normally Closed (NC) or Normally Opened (NO) through the USB or RS232 port. By default, the EPO connector is Normally Closed (NC) by a jumper in the rear panel. If the jumper is removed, the UPS output will not supply energy to the load until the EPO status is changed. To return to normal status, the EPO connector must be closed. Enter the LCD settings to clear the EPO status (LCD settings-->LCD Program 15 EPO warning clearance). The UPS alarm is cleared and bypass mode is recovered. Set the UPS to inverter mode manually.

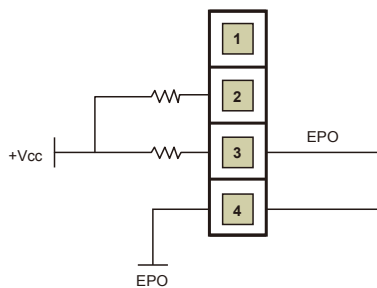

6.3-1

6.3.1 Dry IN

Dry in allows a remote action to switch on/ switch off/ maintenance bypass the UPS. This is done by switching the contact from closed to open.

6.3.2 Dry OUT

The dry out port is normally open. If the dry out port is open, it indicates that the UPS is running in summary alarm / on battery / battery low / UPS ok / on bypass.

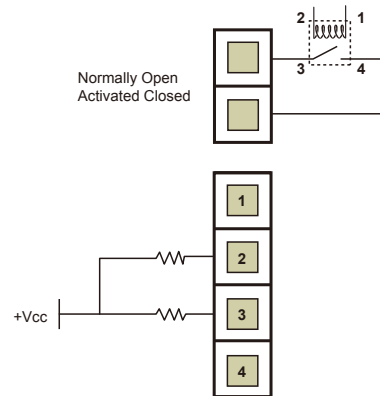

6.3.2-1

6.4 Network management card (optional)

The PowerValue 11 RT G2 1–3 kVA is equipped with an intelligent slot for optional cards for remote management of the UPS through the Internet/ Intranet. Either of the following accessories can be installed in the intelligent slot:

- **SNMP/Modbus Card** – SNMP/Modbus, HTTP and monitoring capabilities through a Web browser interface.
- **AS400 Card** – AS400 card for AS400 communication protocol.

6.4.1 Installing a serial network management card (optional)

Each UPS has a communication slot for an optional serial network management protocol (SNMP/Modbus) card. After installing an SNMP/Modbus card, an environmental monitoring probe can be connected.



THE UPS DOES NOT HAVE TO BE SHUT DOWN BEFORE INSTALLING A COMMUNICATION CARD.

To install a network management card:

1. Remove the two screws that protect the communication slot of the UPS.
2. Insert the SNMP/Modbus card into the communication slot.
3. Screw the SNMP/Modbus card onto the slot using the screws removed in Step 1

For more information on the SNMP/Modbus Cards, see the SNMP/Modbus user's manual.

6.4.2 Monitoring software

The UPS can be monitored using software. The software provides a remote and safe shutdown for multi-client systems in case of absence of power at the UPS output. Instructions on how to install the software are provided with the network management cards.

For more information, contact your local supplier.

7 Troubleshooting

7.1 Fault identification and rectification

Alarms and events indicate warnings and notify of errors or potential failures in the system. The output of the UPS is not necessarily affected when an alarm arises but taking the correct actions may prevent loss of power to the load.











7.2 Accessing alarms

7.2.1 Faults Reference Code

Fault event	Fault code	Icon
Bus start fail	01	X
Bus over	02	X
Bus under	03	X
Bus unbalance	04	X
Inverter soft start failure	11	X
Inverter voltage high	12	X
Inverter voltage Low	13	X

Fault event	Fault code	Icon
Inverter output short	14	X
Battery voltage too high	27	X
Battery voltage too low	28	X
Over temperature	41	X
Overload	43	
Charger failure	45	X

7.2.2 Warning indicator

Warning	Icon (flashing)	Alarm
Low battery		Sounding every second
Overload		Sounding twice every second
Battery is not connected		Sounding every second
Over charge		Sounding every second
Over temperature		Sounding every second
Charger failure		Sounding every second
Battery fault		Sounding every second
Out of bypass voltage range		Sounding every second
Bypass frequency unstable		Sounding every second
EEPROM error		Sounding every second

Symptom	Possible cause	Remedy
No indication and alarm even though the mains is normal.	The AC input power is not connected well.	Check if input power cord firmly connected to the mains.
	The AC input is connected to the UPS output.	Plug AC input power cord to AC input correctly.
The icon  and  flashing on LCD display and alarm is sounding every.	The external or internal battery is incorrectly connected.	Check if all batteries are connected well.
Fault code is shown as 27 and alarm is continuously sounding.	Battery voltage is too high or the charger is faulty.	Contact your dealer.
Fault code is shown as 28 and alarm is continuously sounding.	Battery voltage is too low or the charger is faulty.	Contact your dealer.
The icon  and  flashing on LCD and alarm is sounding twice every second.	UPS is overloaded.	Remove excess loads from UPS output.
	UPS is overloaded. Devices connected to the UPS are fed directly by the electrical network via the bypass.	Remove excess loads from UPS output.
	After repetitive overloads, the UPS is locked in the bypass mode. Connected devices are fed directly by the mains.	Remove excess loads from UPS output first. Then shut down the UPS and restart it.
Fault code is shown as 43 and the icon  is lighting on LCD and alarm is continuously sounding.	The UPS shut down automatically because of overload at the UPS output.	Remove excess loads from UPS output and restart it.
Fault code is shown as 14 and alarm is continuously sounding.	The UPS shut down automatically because short-circuit occurred on the UPS output.	Check output wiring and if connected devices are in short-circuit status.
Fault code is shown as 01, 02, 03, 04, 11, 12, 13, 41 and 45 on LCD and alarm is continuously sounding.	A UPS internal fault has occurred. There are two possible results: 1. The load is still supplied, but directly from AC power via bypass. 2. The load is no longer supplied by power.	Contact your dealer
Battery backup time is shorter than nominal value	Batteries are not fully charged	Charge the batteries for at least 5 hours and then check capacity. If the problem still persists, consult your dealer.
	Batteries defective.	Contact your dealer to replace the battery.

—
www.abb.com/ups
ups.sales@ch.abb.com

