

Eaton 9PHD Industrial UPS

Reliable.
Efficient.



Powering Business Worldwide

Protect your people and profit

An unexpected loss of power in critical industrial applications can result in anything between economic setbacks or physical damages to the worst case of the loss of human lives. It is clear that reliability quickly becomes number one requirement for an industrial UPS.

Our job is to ensure the reliable supply of uninterrupted clean power to keep your critical load up and running no matter what. **Reliability equals safety.**



RELIABILITY



EXPERIENCE
of serving the applications



PRODUCT DESIGN
Avoiding "conditions apply" designs



MANUFACTURING PROCESS
Quality through processes



PRODUCT FEATURES
Resiliency of the UPS system in various conditions

Whatever the changing conditions – and however quickly they change – the Eaton 9PHD UPS is designed to maintain a steady, uninterrupted, clean power supply. This market-leading resiliency is the result of a number of advanced technologies built-in to the 9PHD.

Hot Sync

Hot Sync is a patented load-sharing technology for parallel operation of UPS inverters, without communication or load-share signals. Not relying on communication link or master-control topology, the Eaton 9PHD UPS provides the highest possible reliability by eliminating the single point of failure in a parallel operating UPS system.

Advanced Battery Management

The Advanced Battery Management (ABM) extends the life of valve-regulated lead-acid (VRLA) batteries, through an intelligent charging routine. The advanced battery management run by the Eaton 9PHD intelligent charger provides two level battery system monitoring as well as maximizes the battery lifetime. Other charger features include temperature compensated charging and boost charging. ABM technology is widely used and accepted technology with a 20-year proven track-record.

ABM technology significantly increases battery service life

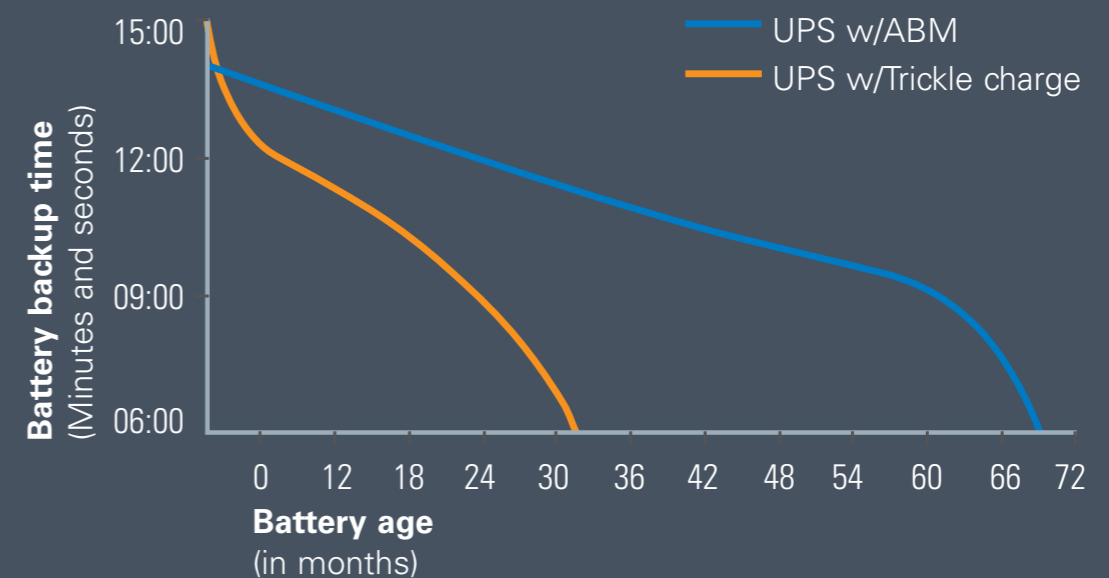

Flexibility and availability

Modular structure can ensure the simplest possible configuration to meet site-specific UPS power and redundancy requirements flexibly. The Uninterruptible Power Modules are able to operate independently, introducing inherent redundancy and maximizing availability of the critical load.

Cut your operating expenses by more than 40%

While the reliability of the UPS system is essential for the continuation of operations, so is financial performance. You want your UPS to stay online 24/7 so minimizing unnecessary losses has a monumental impact on your budget. At the same time, it helps you conduct your business in environmentally friendly manner.

A high efficiency of up to 97% in double conversion mode and 99% in ESS mode means less energy burned to heat and further less energy used for cooling, in other words less money spent on fuel and fewer emissions to the environment. By savings we mean saving the money, weight, space, and environment.

Less money spent on heating and cooling the air. More power available where it matters.

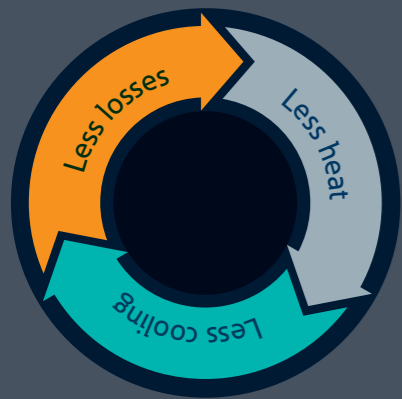

Did you know that the purchase price is just a fraction of the UPS cost? More than ¾ of the UPS cost comes from operating the unit. Use your money wisely and invest in high efficiency, reliability, and serviceability.

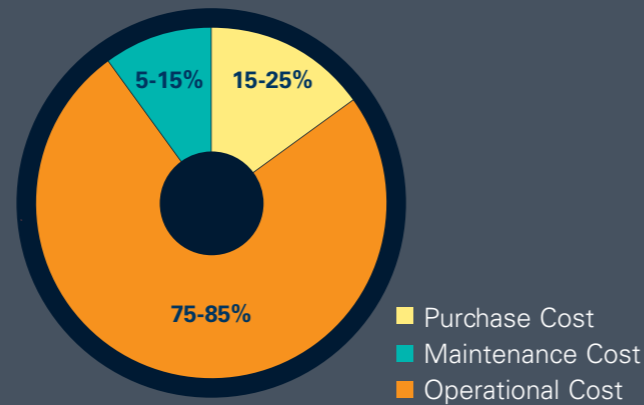

The Eaton 9PHD costs you less to own because it is more efficient, thanks to a number of leading technologies – some of them unique to Eaton.

Ultimate savings

Energy Saver System (ESS) improves the 9PHD efficiency levels to 99%, by suspending the power modules when power conditioning is not required. The power is fed through the static bypass line, with double conversion operation available in less than 2ms, in the event of exceeding pre-set input limits. In addition to extremely low losses, the ESS mode provides filtering against fast low-energy transients.

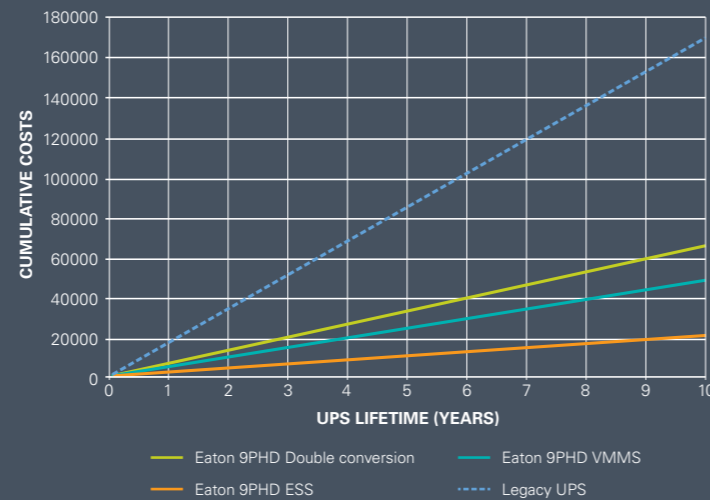

Optimised double conversion

Variable Module Management System (VMMS) helps to achieve high efficiency even when UPS load levels are low – typical for redundant UPS systems. VMMS can optimize the load levels of power modules in a single UPS or in parallel UPS systems, by suspending extra UPS capacity. The result is optimal online efficiency at all load levels. The technology is resilient against sudden changes in load level or in available UPS capacity thanks to the Hot Sync technology.



REDUCTION IN OPERATION EXPENSES

Double conversion efficiency

High online efficiency significantly lowers operation costs and provides savings in cooling. Replacing an older generation UPS with a Eaton 9PHD will be paid back in 3-4 years.



Easy Capacity Test

The Eaton 9PHD is capable of conducting a capacity test by directing the power to loads parallel to the UPS. This both eliminates any costs related to a separate load bank setup and the losses for the test run.

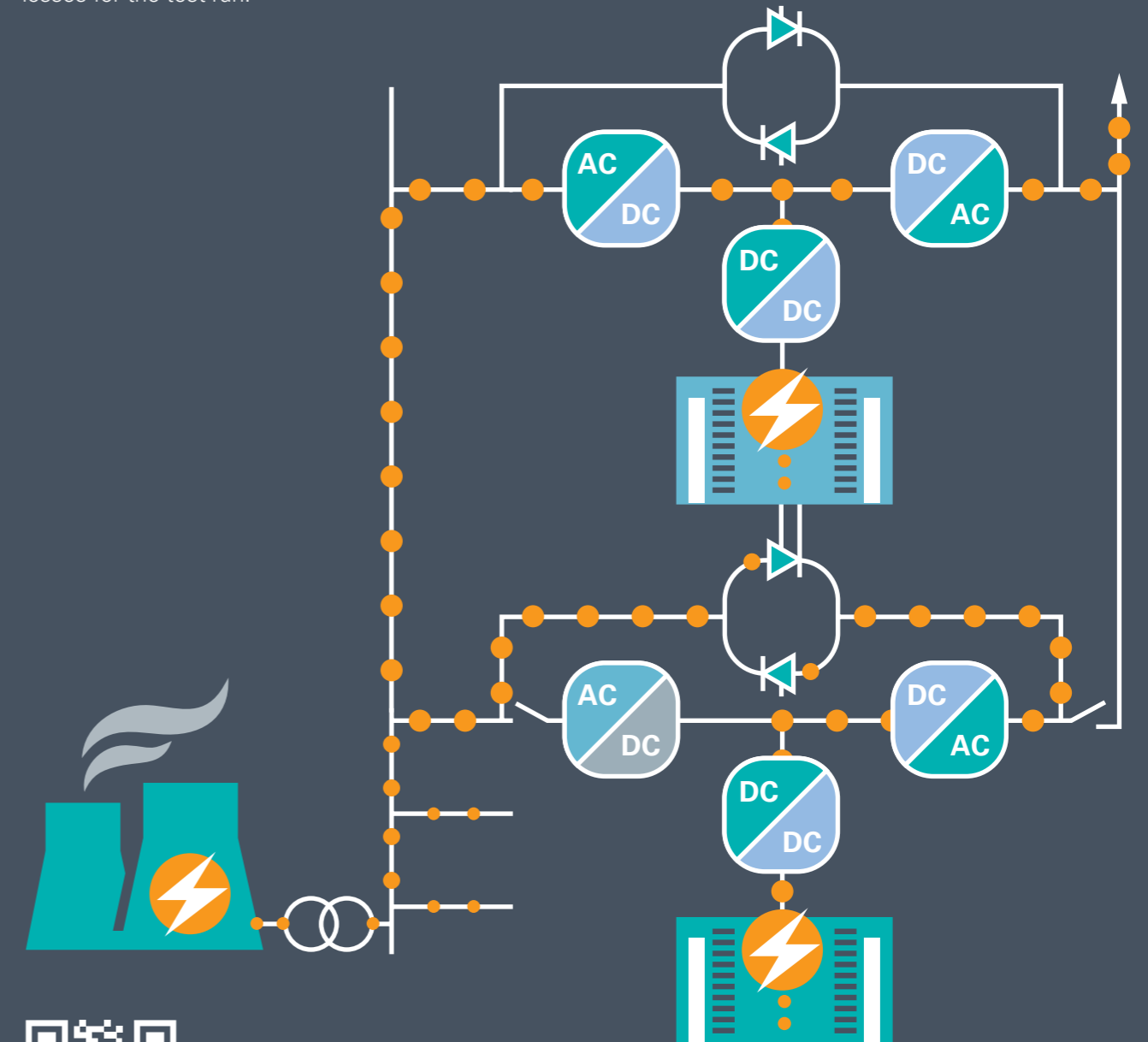

What's in it for me?
Check Eaton's new TCO calculator eaton.eu/TCO

UPS anatomy & features

3 phase power module:

- <4% power lost in double conversion mode on nominal load
- Comprises of independent rectifier, battery charger, and inverter
- Each module has local control logic to eliminate single points of failure
- Monitored redundant cooling fans
- Battery start feature
- Coated PCB boards
- Configurable soft start for generator compatibility

Robust frame and plating:

- 1,5mm thick zinc coated steel plating
- Powder coated to RAL7035 as standard
- Available as seismic proof version on request

Optional internal transformers:

- To provide voltage conversion, galvanic isolation and coping with different grids
- Factory tested and installed
- Reduces cabling time at site by 50%
- Reduces installation footprint up to 50%
- Fans and temperature monitored by the UPS

Power connections:

- Large cabling area for easy commissioning
- Designed for double insulated halogen-free power cables
- Supports dual cabling

Lifting lugs:

- For easy maneuvering of the unit at the site

" 7" HMI touch screen display

- User-friendly access to status information and controls to minimize the risk of human error
- Integrated status LED indicators for quick and easy detection of the system status

Rectifier input switch and maintenance bypass switch:

- Isolates serviceable parts for fast maintenance

Main control unit:

- System level control and commands

Door and filter assembly:

- Double triangle locks
- Door stopper to hold the door in place during maintenance
- Sealed to achieve IP-protection of IP23, IP33 or IP54 depending on site requirements

Signal terminals:

- Optional earth fault monitoring
- Emergency power off interface
- Monitor the ambient conditions or remotely manage the UPS with connectivity accessories

Floor mounting options:

- Available with wheels, vibration dampers or seismic glands

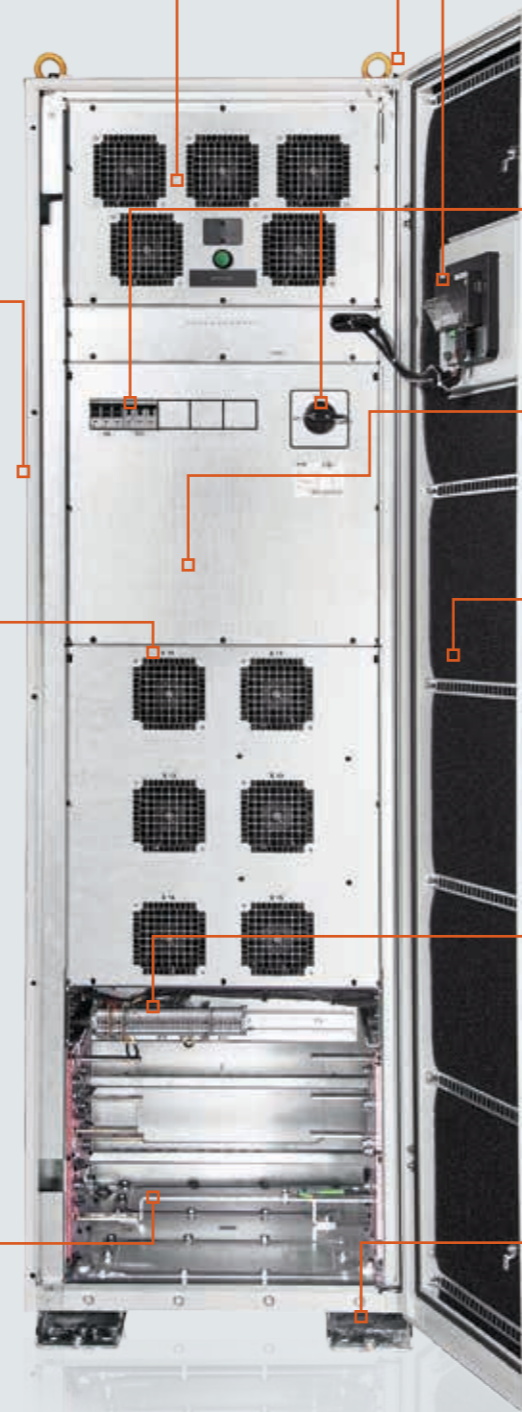

Service and serviceability

The serviceability of the Eaton 9PHD UPS is the result of close relationship with R&D and customer quality functions. For securing the uptime with the lowest operating cost the Eaton 9PHD is built maximizing Mean Time Between Critical Failure (MBTCF) and minimizing Mean Time to Repair (MTTR). The predictivity of the unit performance means less variance in the estimated total cost of ownership - the most relevant measure of UPS cost.

When you choose Eaton UPS on top of reliable and serviceable product you also have access to Eaton's global UPS service coverage with more than 1200 UPS service specialists ready to serve you and your UPS hardware. For UPS units located in remote and hard to access locations, we offer remote monitoring and event management through the optional communication options.

If you need increased autonomy over UPS service, Eaton also welcomes you to join our service training facility that covers all 3ph UPS products sold in the EMEA region to get UPS model specific service training. Together with proper training, pre-engineered spare parts kits and the Eaton 9PHD's design for serviceability you can gain greater autonomy over your UPS service for that extra layer of certainty.

Ask your local sales office for more information or visit eaton.com/UPSservices

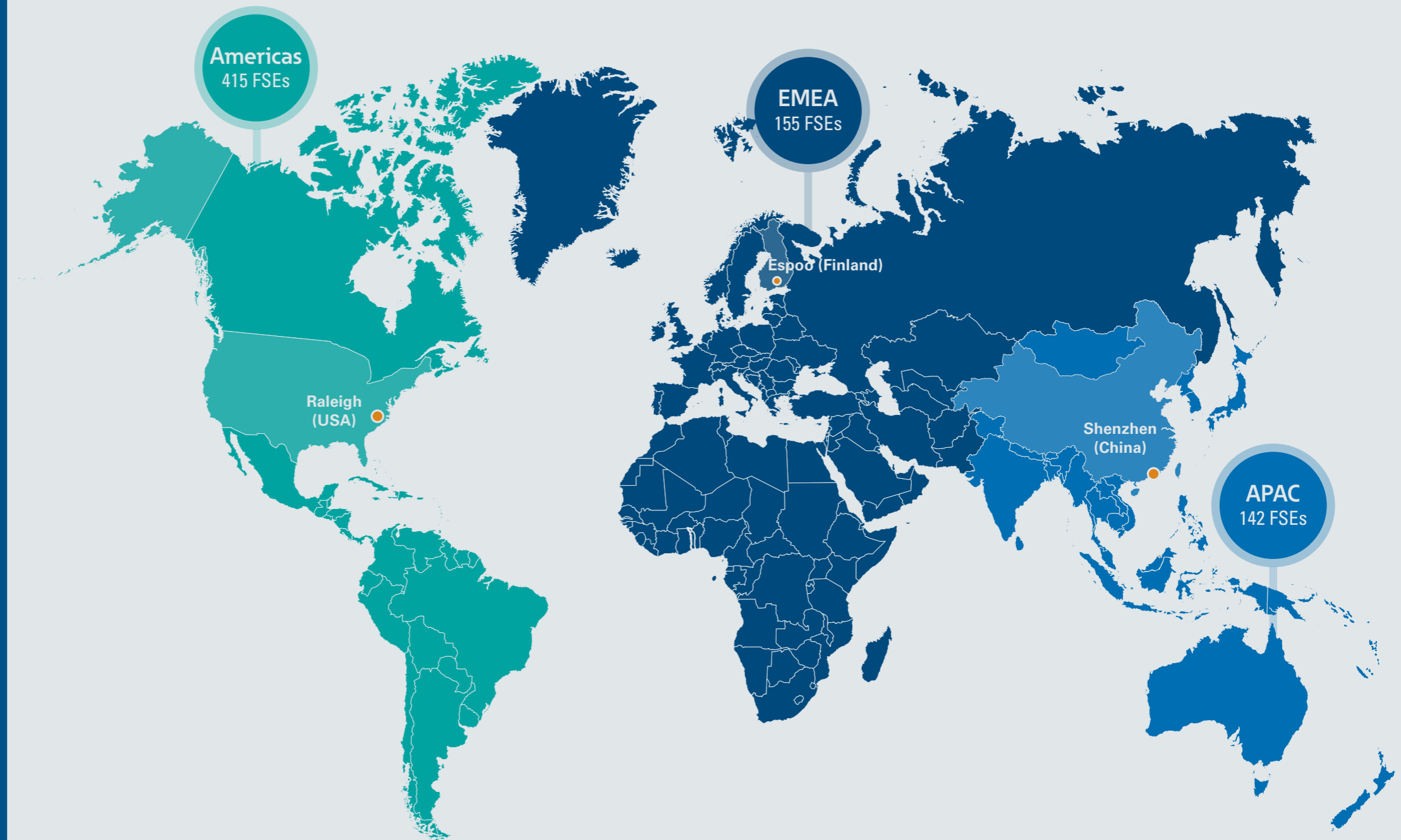

*The numbers do not include FSEs from authorized service partners.

**FSE = Eaton UPS Field Service Engineers.

Accessories and power reserve options

To complete your industrial UPS system the Eaton 9PHD product family includes a range of accessories such as matching battery and transformer cabinets, communication and relay cards, and of course various back up energy mediums.

Wide selection for stored energy:

- VRLA
- Li-Ion
- NiCd
- Super Capacitors

Other optional accessories:

- Matching external transformer cabinet
- Internal ATS
- Internal earth fault monitoring
- Communication monitoring extensions
- Airflow management options eliminate the need for separate battery room



Supercapacitors:

A short runtime back-up power solution has traditionally meant high-maintenance batteries or a less efficient mechanical flywheel. The new Eaton XLM Supercapacitor modules can now be integrated with the Eaton 9PHD to offer a new back-up power solution that is highly reliable, economical, maintenance free and manufactured from environmentally friendly materials.

The solution can tolerate high ambient temperatures and provide extremely fast recharge time. The solution can also tolerate high amount of discharge-charge cycles without significant effect to the supercapacitor health.

Eaton 9PHD External Battery Cabinets:

- Built in temperature monitoring for temperature compensated charging
- Available in IP23, IP33, and IP54
- Marine and seismic options
- Lifting lugs available for safe maneuvering at site
- Double triangle locks on doors
- Built in battery breaker with shunt trip function located safely separately from batteries with hydrogen emission in mind
- Option to integrate the cabinet to ventilation system can help avoid the need for separate battery room

Technical specifications

General	
Output power rating (PF 1.0)	30, 40, 50, 60, 80, 100, 120, 150, 160, 200 kW
External paralleling	Up to 8 units with HotSync technology
Efficiency in double-conversion mode	Up to 97%
Efficiency in Energy Saver System (ESS) mode	Up to 99%
UPS topology	Transformer-free IGBT with PWM, double conversion
Degree of ingress protection	IP23, IP33 or IP54
Ambient temperature	0°C to 40°C up to 1000m altitude, higher ratings as option
RoHS/WEEE compliancy	Yes
Input	
Nominal voltage rating	380 V, 400 V, 415 V, 440 V or 480 V, configurable 208 V - 690 V
Input voltage with internal transformers	
Input frequency range	40 - 72 Hz
Input wiring	3ph+N+PE / 3ph+PE
Input power factor	0.99
Input THDi 100% linear load	< 4.5%
Soft start capability	Yes
Internal back feed protection	Yes, for rectifier and bypass lines
Battery	
Battery technology	VRLA, Li-Ion, NiCd, Super Capacitors
Battery voltage range	432 V - 480 V (configurable down to 220 V)
Maximum charging current	29.3 A, 58.6 A, 87.9 A, 117.2 A depending on model
Charging method	Voltage regulated, current limited with Eaton ABM technology
Boost charge function	Yes
Temperature compensation	Yes
Battery start option	Yes
Communications	
MiniSlots	4 communication bays for Web/SNMP, ModBus/Jbus & Industrial realy
Standard connectivity ports	Mini-slot ports for optional cards, Device USB and Host USB, RS-232 service port, relay output, 5 building alarm inputs, 1 relay output and a dedicated EPO

Output	
Output wiring	3ph+N+PE / 3ph+PE
Rated output voltage	380 V, 400 V, 415 V, 440 V or 480 V, configurable 208 V - 690 V
Output voltage with internal transformers	
Output frequency	50 Hz / 60Hz configurable
Output UTHD	< 1,5% (100% linear load), < 5% (reference non-linear load)
Default overload capacity on inverter	10 min 102 – 110% load 60 s 111 – 125% load 10 s 126 – 150% load 300 ms > 150% load
Max overload capability on inverter	60 min 102 - 110% load 10 min 111 – 125% load 60s 126 – 150% load 300ms > 150% load
Overload capability on bypass	Continuous < 125% load, 50 ms 2000% load
Rated output power factor	1.0
Load power factor range	0.8 lagging to 0.8 leading

Accessories	
Accessories for UPS	Internal transformers; Vibration dampers with mounting brackets; Lifting lugs; Seismic kit; Internal automatic transfer switch; Single feed kit; Earth fault monitoring; 24V Emergency Power Off (EPO); Special system voltages; Custom colours; Exhaust air management options

Accessory cabinets	Industrial battery cabinets with long-life batteries; Matching transformer cabinet for one or two transformers; External maintenance bypass switch.
--------------------	---

Compliance with standards	
Safety (CB certified)	IEC 62040-1
EMC	IEC 62040-2
Performance	IEC 62040-3
RoHS	EU directive 2011/65/EU
WEEE	EU directive 2012/19/EU
Seismic testing	NEBS GR-63-CORE, Zone 4

Due to continuous product improvement programmes, specifications are subject to change without notice. For product specific specifications, contact Eaton sales representatives.

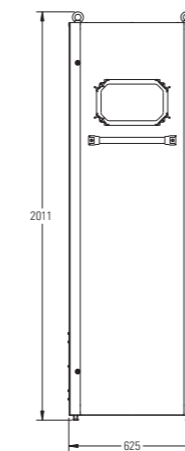

Eaton 9PHD Industrial 30kW-100kW

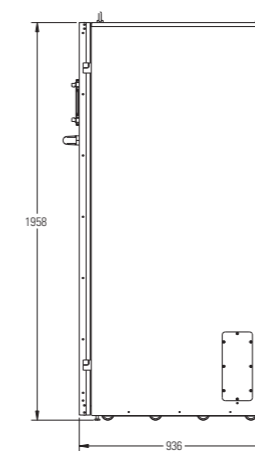

Rear Exhaust

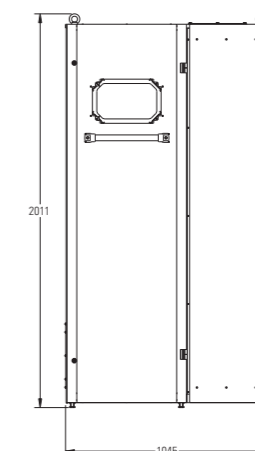

Eaton 9PHD Industrial 80kW-200kW

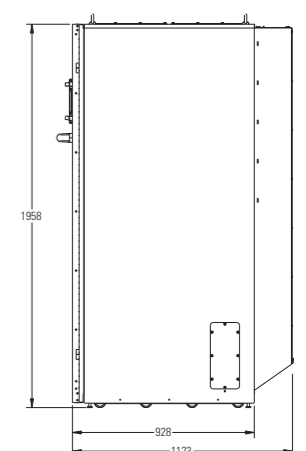

Top Exhaust

